

100% Money Back
Guarantee

Vendor: Cisco

Exam Code: 350-026

Exam Name: CCIE SP Content Networking ENU

Version: Demo

Question No : 1

To maintain schema-consistency in an LDAP Directory Information Tree (DIT), the LDAP standard specifies that:

- A.** The client first downloads the DIT schema from the server and then makes sure every request it sends conforms to the schema;
The server therefore doesn't have to check DIT for consistency
- B.** The operator periodically scans the DIT to check that the schema is not violated, and manually corrects any inconsistencies caused by clients
- C.** The server periodically scans the DIT to check that the schema is not violated, and sends a notification to the operator when it finds an inconsistency caused by clients
- D.** The server periodically converts the DIT to an SQL database; Schema-checking is done by the SQL engine and then the database is converted back to a DIT
- E.** The server checks every client operation for schema consistency, and ignores requests that would result in a DIT inconsistency

Answer: E

Question No : 2

Click the Exhibit button to view the topology.

The diagram shows an L2 switched campus. Switch X is the STP root and switch Y is the standby root. How many of the links in the diagram will be placed in blocking mode by STP?

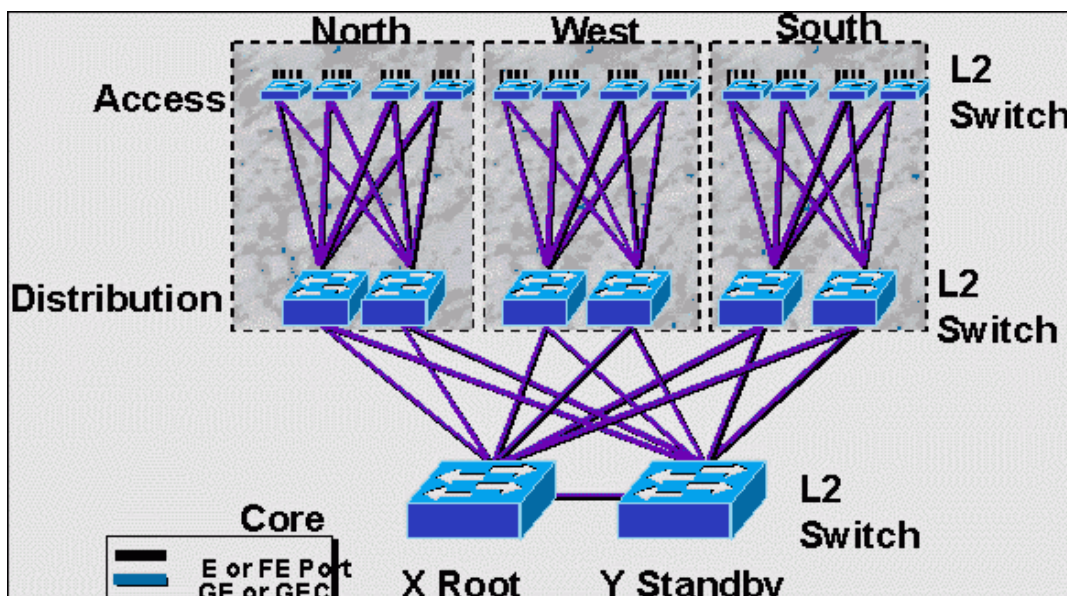

-
- A. 6
 - B. 7
 - C. 12
 - D. 13
 - E. 18
 - F. 19

Answer: E

Question No : 3

In ACNS 5.X Content Delivery Network what is the purpose of defining a root Content Engine for a channel?

- A. This Content Engine retrieves content from other Content Engines within the CDN.
- B. This Content Engine is used by the administrator to manage the Content Delivery Network.
- C. This Content Engine downloads the content from the origin server and distributes the content to all the Content Engines that belong to the Channel.
- D. This Content Engine downloads the content from the Content Distribution Manager and distributes the content to all the Content Engines that belong to the Channel.
- E. None of the above

Answer: C

Question No : 4

What is the usual procedure taken if an unrecognized non-mandatory ISDN IE is received by a network?

- A. Final handle the call
- B. Final handle the call if 2 such IE is received
- C. Ignore only if the IE received is not CS0, otherwise final handle the call
- D. Send a Facility msg to the user notifying the user of sending unknown IEs but don't final handle
- E. Ignore the IEs

Answer: E

Question No : 5

Click the Exhibit to view the topology.

In this network, Host A is trying to reach Host D. There is no routing protocol running, but Router B and C have the following static routes configured:

Router B: `ip route 10.1.3.0 255.255.255.0 ethernet 1`

Router C: `ip route 10.1.1.0 255.255.255.0 ethernet 1`

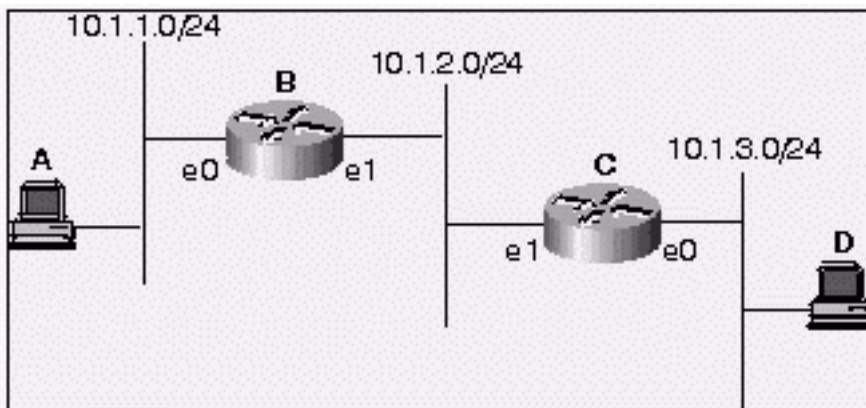

- A. This will not work because Router B has no idea of how to forward traffic to the 10.1.3.0/24 network.
- B. This will work because Router B will recognize that Router C is on the 10.1.2.0/24 network through a router discovery protocol and will forward traffic for 10.1.3.0/24 to Router C.
- C. This will not work because a broadcast interface in a static route command cannot be specified.
- D. This will work because Router B will ARP for Host D's IP address on the 10.1.2.0/24 network and Router C will answer.

Answer: D

Question No : 6

On the CSS, how would you configure a domain name content rule for www.acme.com?

- A. `"www.acme.com/*"`
- B. `"/www.acme.com/*"`
- C. `url "://www.acme.com/*"`
- D. `url "/www.acme.com/*"`

Answer: C

Question No : 7

ATM cells are received across a link on a:

- A. Known PVC or SVC value
- B. Known VCI or VPI value
- C. Known PVC or VCI value
- D. Known SVC or VPI value

Answer: B

Question No : 8

MPLS traffic engineering routing information is carried by:

- A. BGP MEDs
- B. MP-BGP
- C. OSPF Opaque LSAs or IS-IS TLVs
- D. RTP or RTCP packets

Answer: C

Question No : 9

WCCP is a communication protocol used between routers and cache devices. On what port does this protocol communicate?

- A. 80
- B. 2180
- C. 8080
- D. 52
- E. 2048

Answer: E

Question No : 10

Click the Exhibit button to view the topology.

If Switch C1 is the root of the spanning tree for all VLANs in the network, what ports will be blocking on Switch C1?

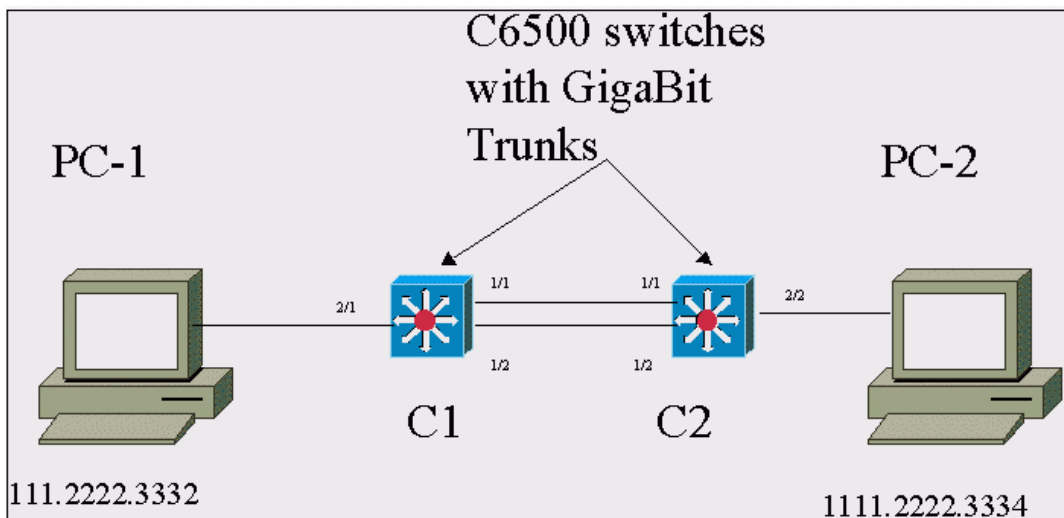

- A. 1/1 only
- B. 1/2 only
- C. Both 1/1, and 1/2
- D. Not enough information

Answer: D

Question No : 11

Click the Exhibit button.

In the shown diagram, the Cisco Cache Engines are configured in a reverse proxy fashion. On the CSS, for what type of service must the cache engines be configured?

Reverse Proxy Cache

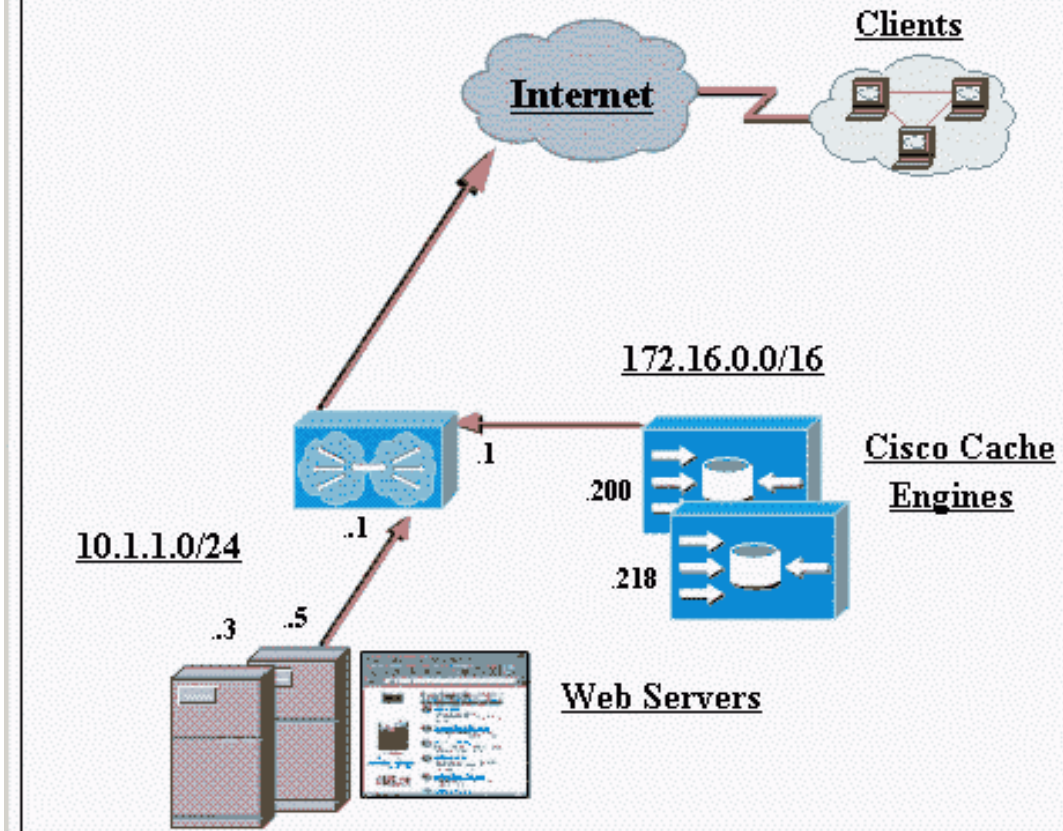

- A. Type transparent-cache
- B. Type proxy-cache
- C. Type local
- D. Type redirect
- E. No type needs to be specified

Answer: A

Question No : 12

Click the Exhibit button.

When loadbalancing RADIUS accounting information, the design needs to:

RADIUS accounting loadbalancing

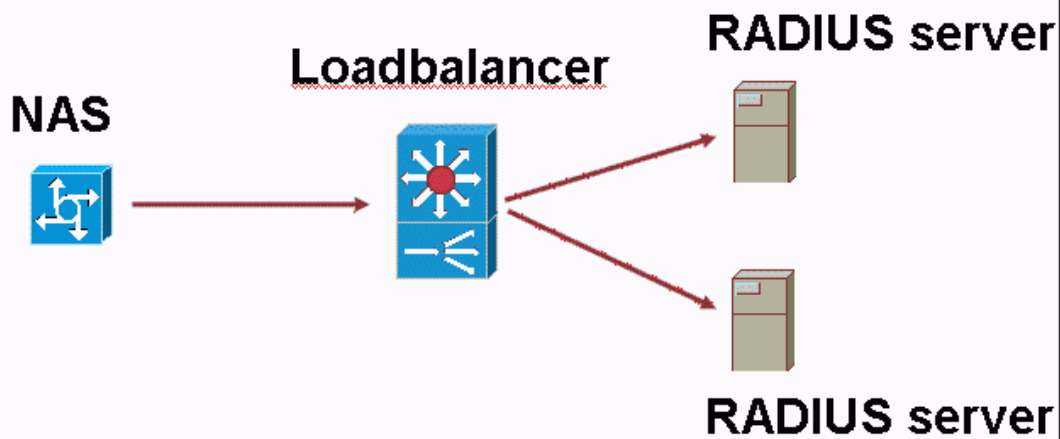

- A. Ensure the accounting data goes to the same server as the server that authenticated the user
- B. Incorporate a method to synchronise the accounting databases on the servers
- C. Ensure Start/Stop records of the same accounting session are sent to the same server
- D. Match the RADIUS Authenticator of Authorization and Accounting information
- E. Incorporate a method to synchronize TACACS+ and RADIUS accounting information

Answer: B,C

Question No : 13

An HTTP response code of 404 indicates:

- A. The transaction is successful.
- B. Object moved.
- C. Bad request.
- D. Unauthorized.
- E. Not found.

Answer: E

Question No : 14

What are the 4 bridge port states in a transparent bridging environment?

- A. Spanning, learning, blocking, forwarding
- B. Connecting, learning, spanning, forwarding
- C. Listening, learning, blocking, forwarding

-
- D. Broadcasting, listening, forwarding, blocking
 - E. Learning, forwarding, connecting, blocking

Answer: C

Question No : 15

A router is receiving updates for a subnet from different routing protocols. The administrator wishes to take advantage of a path via a route with a less favorable Administrative Distance. What can be done to affect this without losing any of the updates?

- A. Configure a static route with an Administrative Distance of 120
- B. Use the Router Configuration mode command distance with an appropriate 'weight' for this subnet
- C. Create a distribute-list to block this subnet
- D. Modify the default-metric weight of the routing protocol offering the more favorable Administrative Distance

Answer: B

Question No : 16

In box-to-box redundancy on the CSS, to configure an ip circuit (VLAN) as a redundant circuit, what command is used?

- A. Redundant-circuit
- B. Redundant-type-circuit
- C. Redundancy
- D. Redundancy-type-circuit
- E. None of the above

Answer: C

Question No : 17

Click the Exhibit button to view the topology.

In this diagram, Host G is attempting to send a packet to Host A through Router E. All routers are running EIGRP, and Router E has installed the following route in its routing

table:

10.1.1.0/24 via router F

What will occur when Router E receives packets from Host G that are destined for Host A?

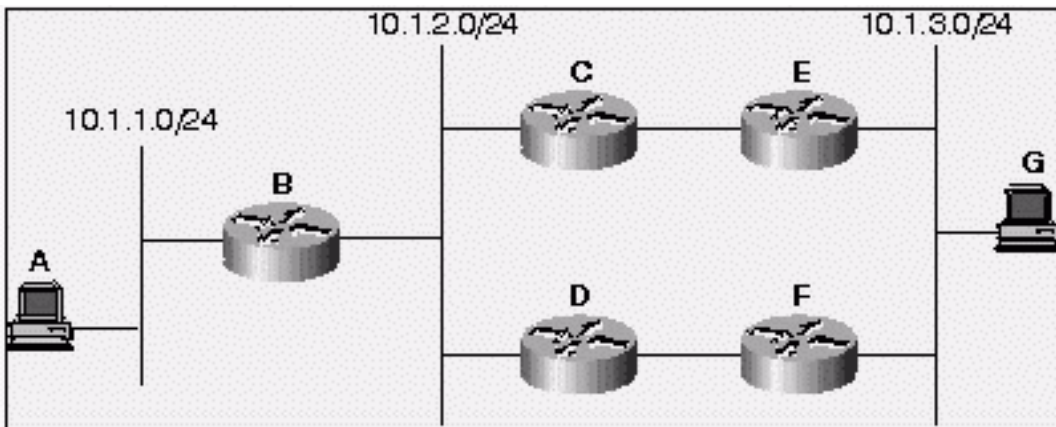

- A. E cannot have a route to 10.1.1.0/24 through F; so it will always choose the path through C.
- B. This is a routing loop; E will forward the traffic to F, and F will send the traffic back to E.
- C. Router E will forward the traffic to Router F.
- D. Router E will forward the traffic to Router F and send a 'host not reachable this direction' ICMP packet to Host G.
- E. Router E will forward the traffic to Router F and send an ICMP redirect to Host G.

Answer: E

Question No : 18

How does RADIUS implement AAA?

- A. Authentication, Authorization and Accounting are in separate exchanges, yet on the same UDP connection. The entire connection is encrypted.
- B. Authentication, Authorization and Accounting are in separate exchanges and each occurs on a different UDP connection. Only the authentication connection is encrypted.
- C. Authentication, Authorization and Accounting are in separate exchanges and each occurs on a different UDP connection. Only the password in the authentication connection is encrypted.
- D. Authentication, Authorization and Accounting are in separate exchanges, yet on the same UDP connection. Only passwords are encrypted.

E. Authentication and Authorization is combined in one exchange. Accounting happens in a separate exchange. Authentication and Authorization data are carried on a UDP connection. The user password is encrypted. Accounting data is carried unencrypted over another UDP connection.

Answer: E

Question No : 19

The website www.foo.com is having problems. The PC you are troubleshooting from does not have a web browser or sniffer software installed. Which method is the next best way to verify that the website will return the web page with content:

- A. tracert www.foo.com 80
- B. ping www.foo.com
- C. telnet www.foo.com 80
GET / HTTP/1.0
- D. telnet www.foo.com 80
- E. telnet www.foo.com 80
HEAD / HTTP/1.0

Answer: C

Question No : 20

What is the proper format for the inverse DNS mapping for the following address:
198.133.219.25?

- A. 198.133.219.25.in-addr.arpa.
- B. 198.133.219.0.in-addr.arpa.
- C. 0.219.133.198.in-addr.arpa.
- D. 25.219.133.198.in-addr.arpa.
- E. 198.133.25.219.in-addr.arpa.

Answer: D

Question No : 21

Select the group of technologies which are listed in descending order of bandwidth scale:

- A. SDH, X.25, ATM
- B. DWDM, SDH, Frame Relay
- C. DWDM, SDH, ATM
- D. ATM, DWDM, Frame Relay

Answer: C

Question No : 22

If a Dialer Profile exists in the local configuration of a router, what is true?

- A. A virtual-access password is configured automatically.
- B. A virtual-access interface will inherit all configurations from the dialer profile.
- C. AAA parameters cannot be applied to an interface.
- D. None of the above

Answer: B

Question No : 23

A router interface address is 180.60.45.96 with a mask of 255.255.255.224. What configuration statement will allow this interface to participate in OSPF Area 0?

- A. router ospf 1
network 180.60.45.96 255.255.255.32 area 0
- B. router ospf 1
network 180.60.45.96 0.255.255.224 area 0
- C. router ospf 1
network 180.60.45.96 0.0.0.31 area 0
- D. router ospf 1
network 180.60.45.96 0.0.0.224 area 0

Answer: C

Question No : 24

Click the Exhibit button.

When loadbalancing LDAP:

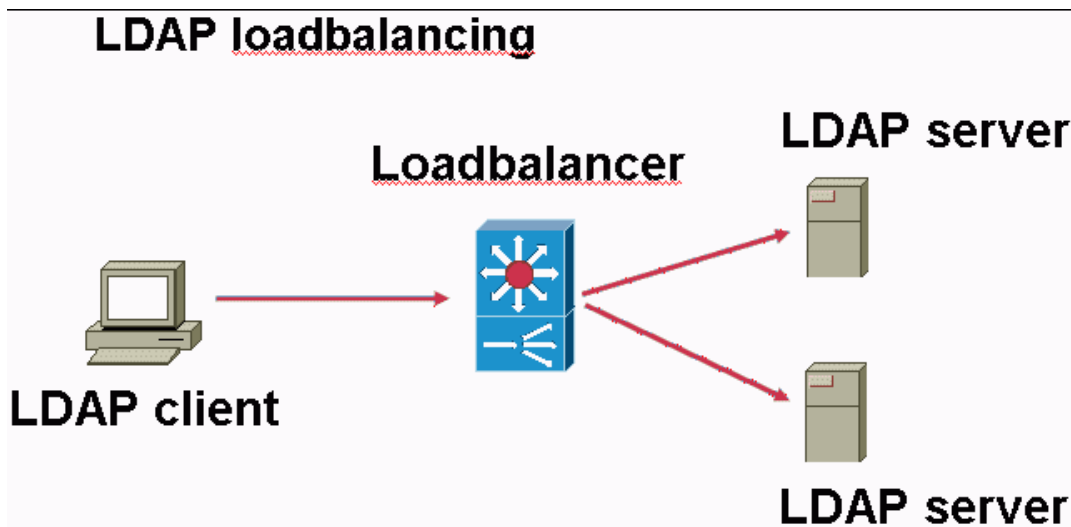

- A. The design must ensure that the LDAP Client Hello goes to the same server as the LDAP Search operation
- B. Problems may occur when the LDAP UDP traffic is not consistently sent to the same server
- C. This typically happens at the Layer 4 level
- D. The loadbalancer must be LDAP-aware so it can send server Call-backs back to the correct client
- E. The loadbalancer must be defined as a Relative Distinguished Name in the Directory Information Tree

Answer: C

Question No : 25

Which three fundamental elements characterize the PKIs used in asymmetric cryptography?

- A. Confidentiality, authorization, message integrity
- B. Confidentiality, authentication, accounting
- C. Confidentiality, authentication, authorization
- D. Confidentiality, authentication, message integrity
- E. Authentication, authorization, accounting

Answer: D

Question No : 26

What signaling protocol does Cisco use to provide support for MPLS traffic engineering?

- A. RSVP
- B. LDP
- C. SS7
- D. TDP

Answer: A

Question No : 27

Routers running OSPF and sharing a common segment become neighbors on that segment. What statement regarding OSPF neighbors is FALSE?

- A. The Primary and Secondary addresses on an interface allow the router to belong to different areas at the same time.
- B. All routers must agree on the stub area flag in the OSPF Hello Packets.
- C. Neighbors will fail to form an adjacency if their Hello and Dead intervals differ.
- D. Two routers will not become neighbors if the Area-ID and Authentication password do not match.

Answer: A

Question No : 28

Above is the configuration of a keepalive on a GSS.

What should be the associated configuration of the CSS?

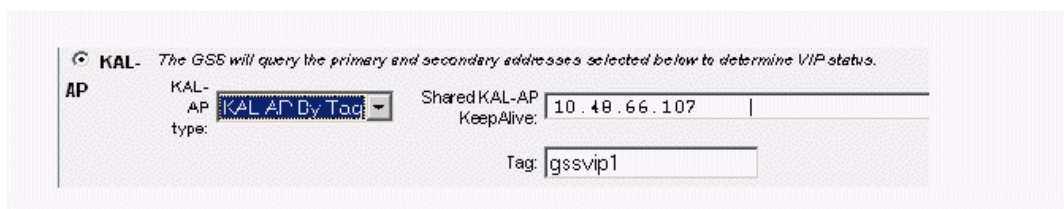

- A. app
owner MyCompany
Content WWW
Vip address 10.48.66.107
add dns gssvip1
- B. app
owner MyCompany

Content gssvip1
Vip address 10.48.66.128
C. app-udp
owner MyCompany
Content WWW
Vip address 10.48.66.107
add dns gssvip1
D. app-udp
owner MyCompany
Content WWW
Vip address 10.48.66.128
add dns gssvip1
E. app-udp
owner MyCompany
Content gssvip1
Vip address 10.48.66.128

Answer: D

Question No : 29

LDAP can be preferred over X.500 because:

- A.** LDAP is a protocol to access Directories and X.500 is not
- B.** LDAP is more generic and allows access to all kind of Directories; X.500 is limited to certificate chains
- C.** LDAP is a lighter version of X.500 as it uses UDP instead of TCP
- D.** LDAP is a lighter version of X.500 as it doesn't require a full OSI stack implementation
- E.** LDAP is cross-platform while X.500 runs only on legacy systems

Answer: D

Question No : 30

To eliminate the need for adjacent routers on broadcast networks to form $n(n-1)/2$ adjacencies, IS-IS defines a pseudonode or Designated Intermediate System, DIS. All router on the broadcast medium form an adjacency with the DIS. The Backup DIS is called:

- A.** Redundant DIS
- B.** BDR

-
- C. There is no concept of a backup DIS in IS-IS
 - D. Designated Redundant System

Answer: C

Question No : 31

What is true about the DLCI field in the Frame Relay header?

- A. It consists of two portions, source and destination, which map data to a logical channel.
- B. It generally has significance only between the local switch and the DTE device.
- C. It is an optional field in the ITU-T specification.
- D. It is present only in data frames sent through the network.

Answer: B

Question No : 32

Parties learn about a CA's Certificate Revocation List (CRL) through:

- A. The CRL which is contained in the CA certificate; It contains a list of all revoked certificates.
- B. The CRL which is contained in the CA certificate; It contains a list of the serial numbers and revocation dates of all revoked certificates.
- C. A CRL Distribution Point or CDP which is contained in the CA certificate and points to a location from which the CRL (a list of the serial numbers and revocation dates of revoked certificates) may be retrieved.
- D. Either the CRL which is contained in the CA certificate, or a CDP from which the CRL may be retrieved. The CRL contains a list of the serial numbers and revocation dates of all revoked certificates.
- E. Either the CRL which is contained in the CA certificate, or a CDP from which the CRL may be retrieved. The CRL contains a list of all revoked certificates.

Answer: D

Question No : 33

Click the Exhibit button to view the topology.

A network engineer is troubleshooting a connectivity problem between Hosts A and B. The following conditions exist: - Host A can ping the firewall, but cannot ping Host B.

- Host B can ping both the firewall and www.cisco.com.
- The firewall can ping www.cisco.com.
- Host C can ping the firewall and www.cisco.com.
- Host A and Host C have the same permissions on the firewall

What is the most likely problem?

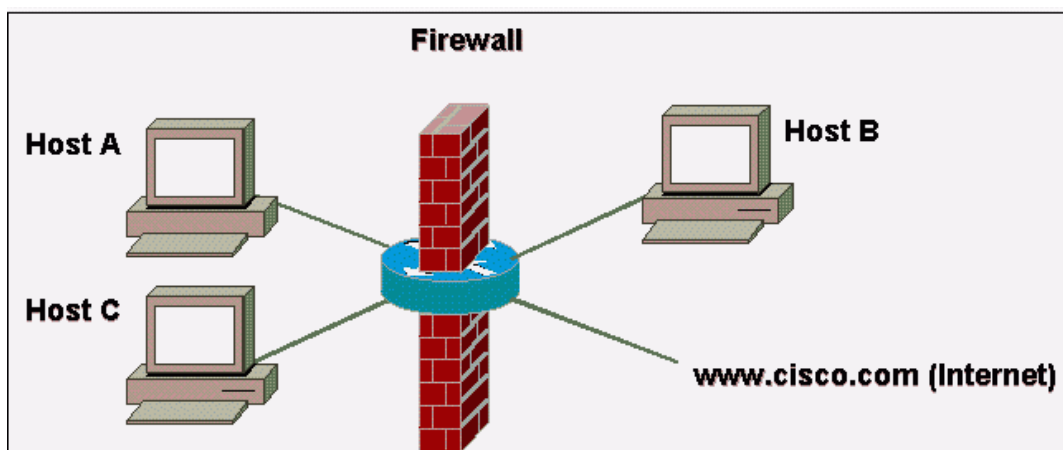

- A. Routing protocols in the network are not set up properly, and not propagating across the firewall.
- B. Host A has an incorrect default gateway configured.
- C. Host B has an incorrect default gateway configured.
- D. Host C has an incorrect default gateway configured.
- E. The firewall has an incorrect default gateway configured.

Answer: B

Question No : 34

When implementing a CSS script, if you are required to close a TCP connection with a TCP FIN, what command should be used?

- A. socket disconnect \${SOCKET}
- B. socket disconnect \${SOCKET}fin
- C. socket disconnect \${SOCKET}gracefull
- D. socket disconnect \${SOCKET}tcpfin

E. socket disconnect tcpfin \${SOCKET}

Answer: C

Question No : 35

Click the Exhibit button.

In the shown diagram the USER is accessing the web application farm for content on port 80 through 7500-1. 7500-1 has WCCP enabled on the router. CE590 is pointing to 7500-1 as a WCCP router. What is the best method of redirection in this topology?

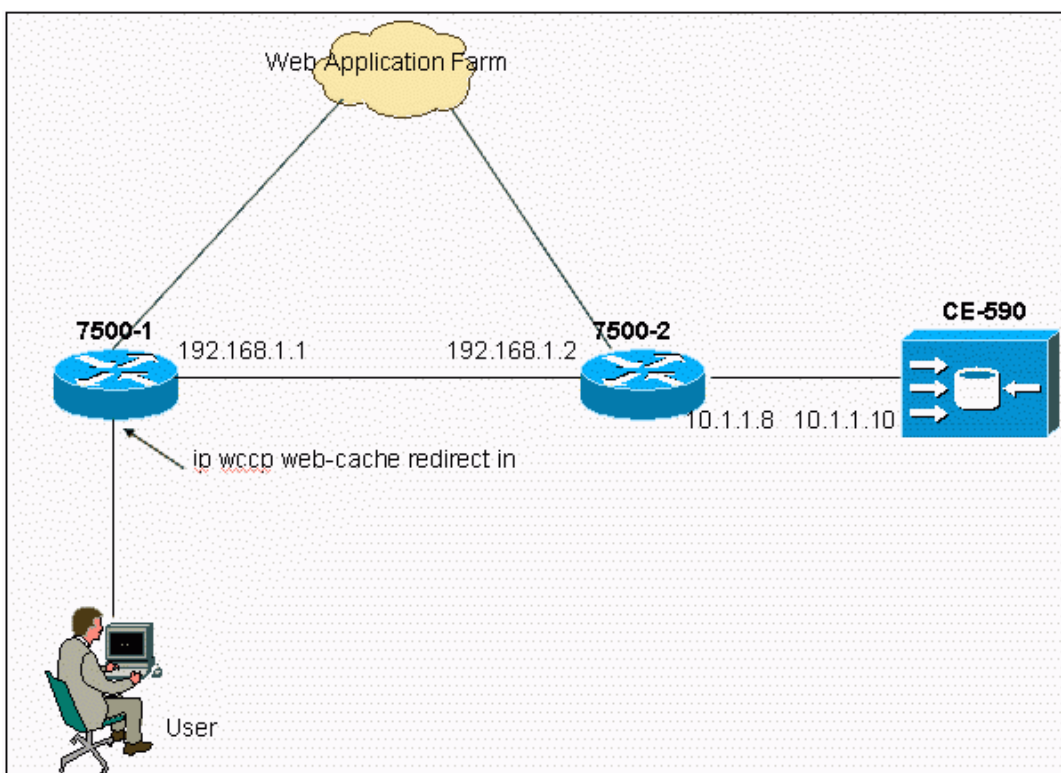

- A. Route map on 7500-1; setting port 80 destined traffic's next hop to 7500-2
- B. Route map on 7500-1; setting port 80 destined traffic's next hop to CE-590
- C. GRE redirection
- D. Layer 2 redirection
- E. Layer 2 redirection with mask assign

Answer: C

Question No : 36

What is a possible way to avoid assymmetric traffic flow when using the CSM for server load balancing and the CSM's server side VLAN has an IP address configured on the MSFC?

- A. In the server farm use the client nat command with a nat pool.
- B. Use policy based routing to force traffic through the CSM's client side VLAN.
- C. Use policy based routing to force traffic through the CSM's server side VLAN.
- D. Set the server's default gateway to the CSM's client side IP address.

Answer: A,C

Question No : 37

What describes a technique, used to encapsulate voice (NOT data) over ATM?

- A. RFC 1483
- B. LANE
- C. AAL-1
- D. RFC 1577

Answer: C

Question No : 38

During an SSL transaction, when a client tries to authenticate the server, the client will:

- A. Check that the server certificate has not expired
- B. Use the Issuer public key to verify the signature of the server certificate
- C. Use the Subject public key to verify the signature of the server certificate
- D. A and B
- E. A and C

Answer: D

Question No : 39

Click the Exhibit button to view the topology.

Host 1 and Host 2 are on Ethernet LANs in different buildings. A serial line is installed between two Cisco routers using Cisco HDLC serial line encapsulation. Routers A and B

are configured to route IP traffic. Host 1 sends a packet to Host 2. What is the destination MAC address of the packet on Host's 1 Ethernet?

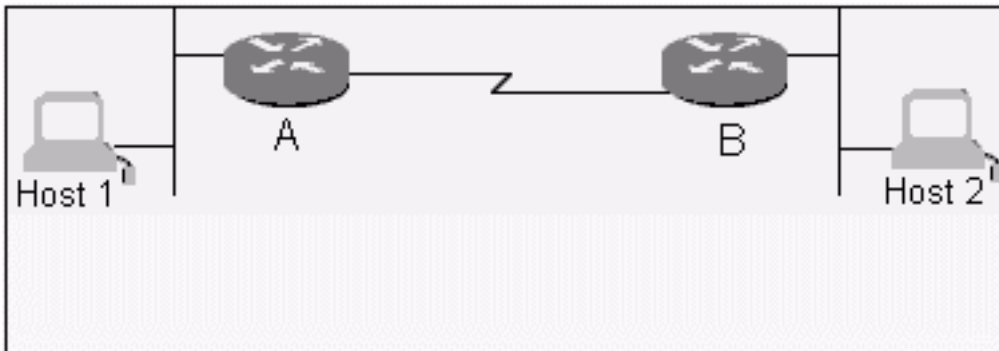

- A. Host 1
- B. Host 2
- C. Router A
- D. Router B
- E. The broadcast address

Answer: C

Question No : 40

OSPF is defined on a Frame Relay interface providing point-to-multipoint connections. The remote neighbors can reach this central site, but are complaining of routing failures between each of the remote sites. The central router has all the routes for each remote site. Based on this information, what can be diagnosed as the biggest potential problem?

- A. An over-subscribed Frame Relay switch will cause some packet loss.
- B. There are problems in the use of OSPF Authentication.
- C. There is an incorrect selection of the Designated Router.
- D. There is an incorrect DLCI assigned on a point-to-point sub-interface.

Answer: C

Question No : 41

Click the Exhibit button to view the diagram.

The address field contains: (multiple answer)

The following figure shows the format of the standard Frame Relay frame:

Field length, in bytes.

8 16 Variable 16 8

Flags	Address	DATA	FCS	Flags
-------	---------	------	-----	-------

- A. The DLCI Value
- B. The Extended Address (EA)
- C. Congestion Control
- D. FCS

Answer: A,B,C

Question No : 42

Click the Exhibit button.

A client at the PC is unable to browse to <http://www.foo.com>. On the firewall, what list of traffic types needs to be passed to allow browsing?

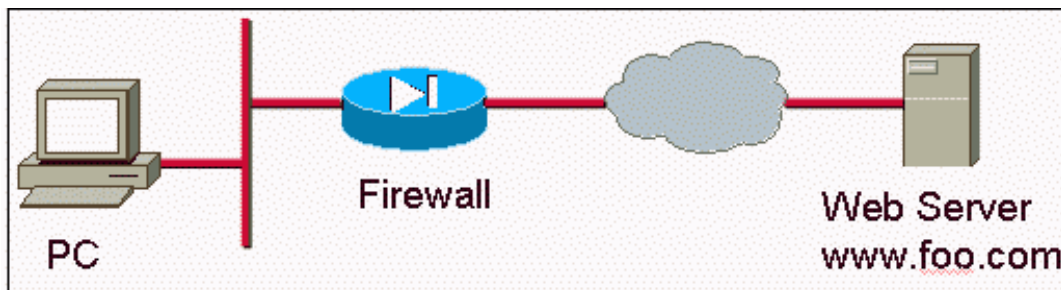

- A. icmp, udp 1645, tcp 8080
- B. udp 53, tcp 80, ftp
- C. ftp, smtp, dns
- D. icmp, tcp 49, tcp 443
- E. tcp 25, ssl, dns

Answer: B

Question No : 43

Click the Exhibit button:

In the shown diagram the browser fails to return a web page when browsing to www.foo.com. The IP addressing is represented by letters next to each device. The domain name www.foo.com resolves to IP address E. A sniffer trace is taken at the PC. What sequence of packets would be observed for this problem:

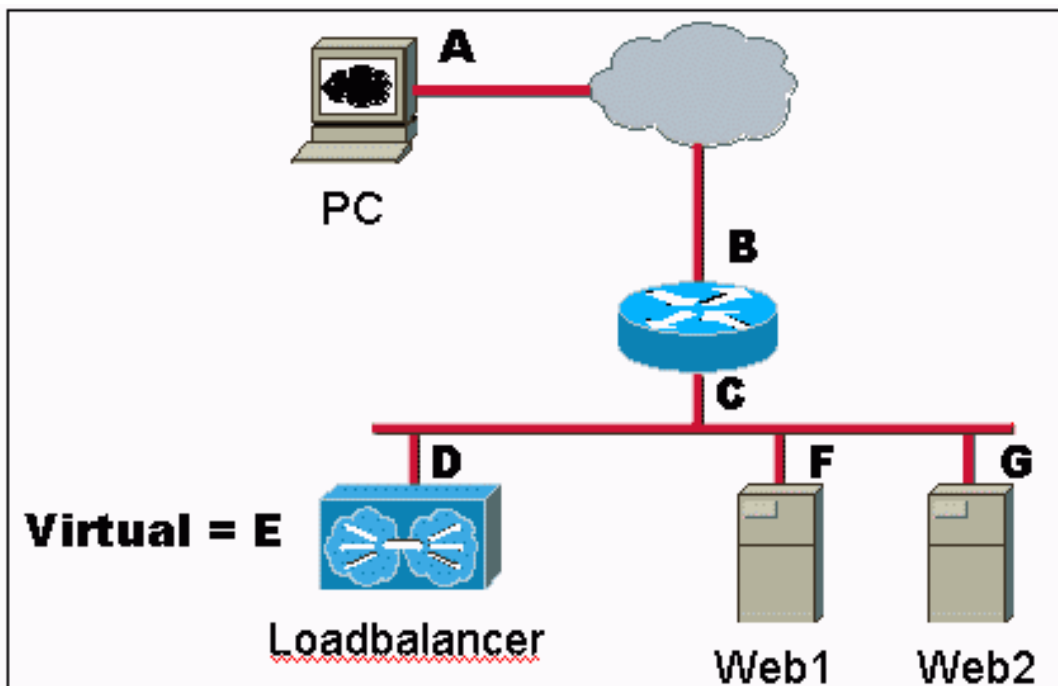

- A. A -> E SYN
- F -> A SYN-ACK
- A -> F RST
- B. A -> D SYN
- D -> A RST
- C. C -> E SYN
- E -> C SYN-ACK
- C -> E ACK
- D. D -> G SYN
- G -> D SYN-ACK
- D -> G ACK
- E. A -> E FIN
- E -> A ACK
- E -> A FIN

Answer: A

Question No : 44

What statement regarding Network Qualifier Lists (NQL) is most correct?

- A. It is used to define a list of IP addresses and networks to simplify and enhance the

implementation of ACLs.

B. It is used to define a list of IP addresses to simplify and enhance the implementation of advanced balanced sticky source IP.

C. It is used to define a list of IP addresses of hosts allowed SNMP access to a Content Smart Switch.

D. It is used to define a list of IP addresses of FTP servers.

Answer: A

Question No : 45

Every time a typing mistake is made at the exec prompt of a router, the message from the router indicates a lookup is being performed. Also, there is a waiting period of several seconds before the next command can be typed. Can this behavior be changed?

A. No, this is a built in feature of Cisco IOS

software.

B. Yes, use the no ip domain-lookup command.

C. Yes, use the no ip helper-address command.

D. Yes, use the no ip multicast helper-map command.

E. Yes, use the no exec lookup command.

Answer: B

Question No : 46

For the spanning tree algorithm, a bridge builds part of its forwarding table based on:

A. Destination MAC addresses

B. 802.2 headers

C. Source MAC addresses

D. The Ethernet type field

E. The SNAP field

Answer: C

Question No : 47

Commercial browsers such as Netscape or Internet Explorer have knowledge of existing root CA certificates because:

- A.** They connect to netscape.com or microsoft.com to download the current list of CA certificates each time the user is on-line.
- B.** A number of root CA certificates is already installed in the software. Users can then manually add or remove certificates to this list.
- C.** A number of root certificates is already installed in the software. This list cannot be altered, but companies can request intermediary CA certificates to be signed by one of these root CAs.
- D.** There exists a standard that outlines which CA's can be trusted ; the browser checks the CA certificate against this standard.
- E.** During installation of the browser, the install program will download the latest list of trusted root CA certificates from download.rsa.org and install these with the browser.

Answer: B

Question No : 48

How does TACACS+ implement AAA?

- A.** Authentication, Authorization and Accounting are in separate exchanges, yet on the same TCP connection. The entire connection is encrypted.
- B.** Authentication, Authorization and Accounting are in separate exchanges and each occurs on a different TCP connection. Only the authentication connection is encrypted.
- C.** Authentication, Authorization and Accounting are in separate exchanges. Authentication and Authorization happen on the same TCP encrypted connection ; Accounting data is carried unencrypted over UDP.
- D.** Authentication, Authorization and Accounting are in separate exchanges, yet on the same TCP connection. Only passwords are encrypted.
- E.** Authentication and Authorization is combined in one exchange. Accounting happens in a separate exchange. Authentication and Authorization data are carried on a UDP transport. Only passwords are encrypted. Accounting data is carried unencrypted over another UDP transport.

Answer: A

Question No : 49

Click the Exhibit button to view the configuration.

Look at the router configuration above. If this router has a configuration-register setting of 0x102, select the proper boot sequence:

```
version 11.2
!
hostname router
!
boot system flash slot0:rsp-isv-mz.112-8.P
enable password cisco
```

- A. The router will try to use the image "rsp-isv-mz.112-8.P" on slot 0, then attempt to boot from a network server, and finally boot from ROM.
- B. The router will try use the image "rsp-isv-mz.112-8.P" on slot 0, then attempt to boot from any other valid image in flash, and finally boot from ROM.
- C. The router will try to use the image "rsp-isv-mz.112-8.P" on slot 0, and then it will boot from ROM.
- D. The router will try to use the image "rsp-isv-mz.112-8.P" on slot 0, and then attempt to boot from a network server.

Answer: A

Question No : 50

How does Transport Layer Security (TLS) differ from SSLv3?

- A. TLS supports Diffie-Hellman ciphers and SSLv3 does not.
- B. The way they derive keys from the master secret.
- C. TLS supports client authentication and SSLv3 does not.
- D. The way in which the Session ID is computed.
- E. All of the above

Answer: B

Question No : 51

What is Forwarding Equivalence Class assignment NOT likely to be based upon?

- A. Fragment offset
- B. Destination address
- C. Application protocol
- D. Class of service

Answer: A

Question No : 52

Click the Exhibit button to view the topology.

Routers E and F are running HSRP (Hot Standby Router Protocol). Router E has a higher priority, and both routers have standby preempt configured. Since Router E is normally the active router, what IP address should Host G use for its default gateway?

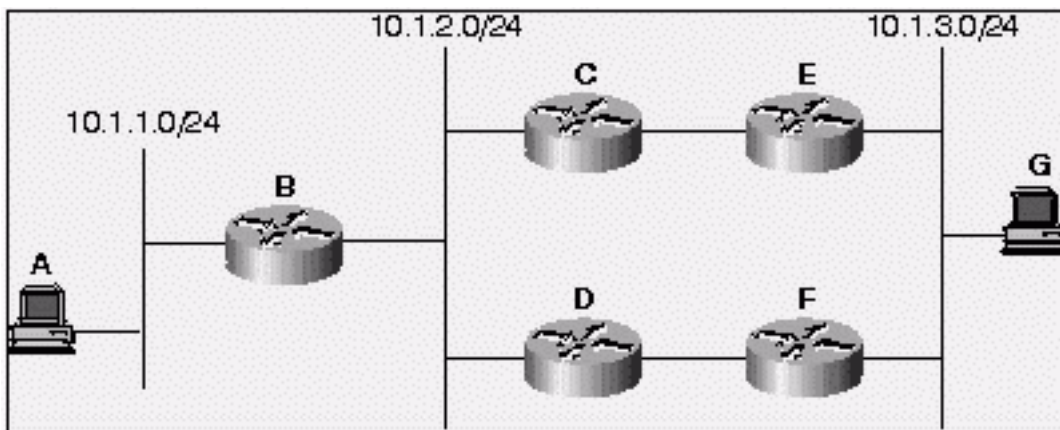

- A. 10.1.3.1
- B. Router E's IP address, since it is normally active; Router F will take over Router E's address if it fails.
- C. Router F's IP address; the active router will take over the standby router's IP address until it fails
- D. The virtual address configured when enabling HSRP
- E. The virtual address assigned by HSRP; this address is dependent on the group number configured

Answer: D

Question No : 53

The network administrator has forgotten the enable password of the router. Luckily, no one is currently logged into the router, but all passwords on the router are encrypted. What should the administrator do to recover the enable password?

- A. Call the Cisco Technical Assistance Center (TAC) for a special code that will erase the existing password.
- B. Reboot the router, press the break key during bootup, boot the router into ROM monitor

mode, and modify the configuration

register so that the current configuration is ignored during normal bootup

C. Reboot the router, press the BREAK key during bootup, and boot the router into ROM Monitor mode to erase the configuration, and re-install the entire configuration as it was saved on a TFTP server.

D. Erase the configuration, boot the router into ROM Monitor mode, press the BREAK key, and overwrite the previous enable password with a new one.

Answer: B

Question No : 54

Within Cisco's Application and Content Networking Software Version 5 and above, Simplified Hybrid Routing utilizes 2 standard protocols to direct a client to a local CE. What are they ?

A. WCCP and proxy

B. Layer 2 redirects and HTTP

C. DNS and WCCP

D. HTTP and HTTPS

E. DNS and HTTP

Answer: E

Question No : 55

A root CA certificate distinguishes itself from other certificates because:

A. The root CA certificate has a special bit set in the Key Usage field.

B. The root CA certificate has its serial number in a dedicated range.

C. The root CA certificate issuer and subject are the same.

D. The root CA certificate has a Subject Type equal to CA in its Basic Constraints.

E. The root CA certificate has a Thumbprint.

Answer: C

Question No : 56

The configuration register does NOT retain settings for:

- A. An enabled 'Break' key
- B. The console baud rate
- C. The boot method
- D. An enabled AUX port

Answer: D

Question No : 57

Click the Exhibit button to view the topology.

Routers E and F are configured for HSRP (Hot Standby Routing Protocol). E has a priority of 100, while F has a priority of 50. At one point, when E is the active router, it fails, and F takes over as the active router. A few minutes later, E returns to service. What happens?

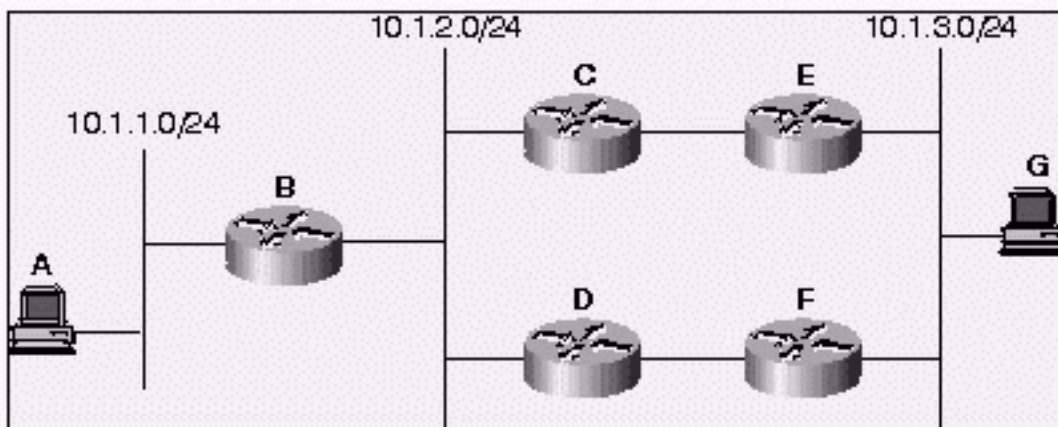

- A. F will remain the active router; there is no way for E to become the active router again unless F fails.
- B. E and F will negotiate which router should be active based on their IP addresses.
- C. E will always take over the active role; there is no way for F to remain active once another router with a higher priority is on the network.
- D. E will become the active router, if it is configured to preempt.
- E. F will remain the active router because having a lower priority is better.

Answer: D

Question No : 58

What is the default port number is used by Cisco's Content Engine Windows Media Server

for streaming data via UDP?

- A. 80
- B. 1755
- C. 8001
- D. 554
- E. 17

Answer: B

Question No : 59

The TCP PUSH flag indicates:

- A. The data in the TCP receive buffer should be sent to the application listening to this TCP connection without waiting for further data.
- B. Any data being buffered by routers between the source and destination for this connection should be sent immediately.
- C. The sender should make certain its send buffer is pushed onto the wire.
- D. This session is about to end.

Answer: A

Question No : 60

Click the Exhibit button to view the scenario.

How should OSPF be configured on Router B?

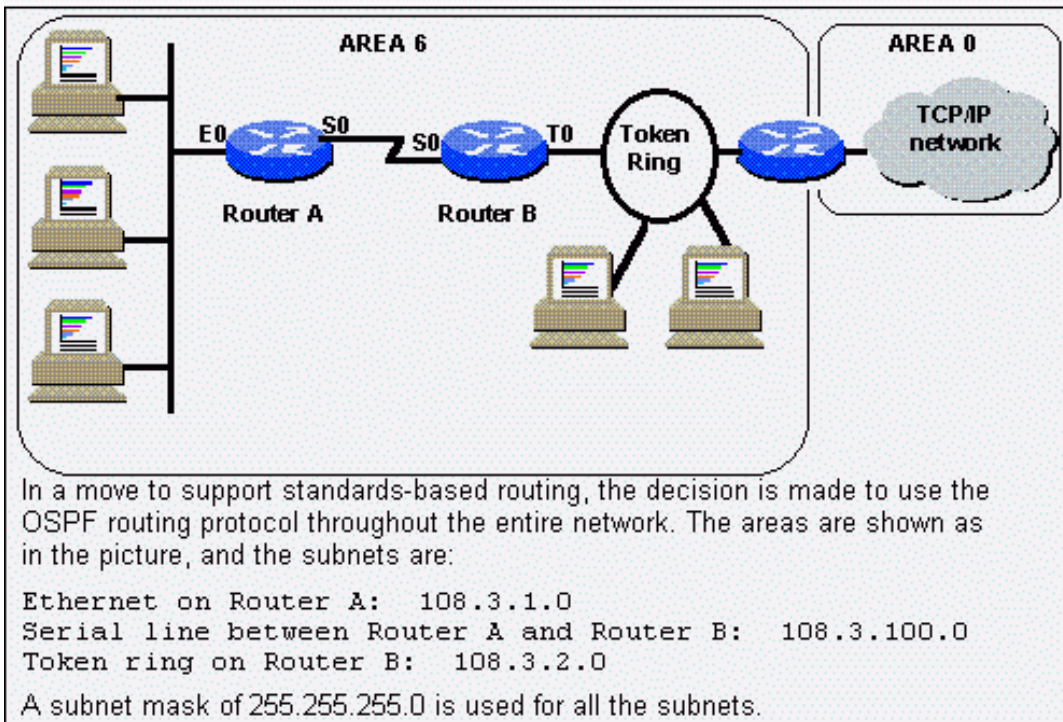

- A. router ospf
network 108.3.0.0
- B. router ospf 1
network 108.3.100.0 0.0.0.255 area 6
network 108.3.2.0 0.0.0.255 area 6
- C. router ospf 1
network 108.3.100.0 0.0.0.255 area 6
network 108.3.2.0 0.0.0.255 area 0
- D. router ospf 1
network 108.3.100.0 255.255.255.0 area 6
network 108.3.2.0 255.255.255.0 area 6
- E. router ospf 1
network 108.3.1.0 0.0.0.255 area 6
network 108.3.100.0 0.0.0.255 area 6
network 108.3.2.0 0.0.0.255 area 6

Answer: B

Question No : 61

In the CSS, configuring redundancy protocol requires you to:

- A. Enable the circuit VLAN for redundancy using the redundancy command.
- B. Enable the redundancy protocol on the master and backup circuit VLAN using the redundancy-protocol command.
- C. Configure the master and backup CSSs for redundancy using the IP redundancy

command.

- D. All of the above
- E. None of the above

Answer: D

Question No : 62

Click the Exhibit button to view the configuration.

Using the shown debugging excerpt, what option best describes the problem?

```
*Mar 1 00:38:43.351: %SGBP-1-AUTHFAILED: Member C4500CD failed authentication
*Mar 1 00:38:57.723: %SGBP-7-NORESP: Fail to response to C4500CD group stack,
may not have password
*Mar 1 00:39:17.719: %SGBP-7-NORESP: Fail to response to C4500CD group stack,
may not have password
```

- A. An ISDN router has a misconfigured username password pair.
- B. An ISDN router is missing the stack password.
- C. The offload server does not offload calls from ISDN routers not using PPP Multilink.
- D. The offload server has a bad password.

Answer: B

Question No : 63

For an OC-48 signal (2.5Gb/s), what is the BER (bit error rate) if there is 1 bit error every four days?

- A. 10E-12
- B. 10E-13
- C. 10E-14
- D. 10E-15
- E. 10E-16

Answer: D

Question No : 64

On a Cisco router running WCCP web-cache, what command will show the number of redirected packets?

- A. show ip wccp web-cache redirect
- B. show ip wccp web-cache view
- C. show ip wccp web-cache detail
- D. show ip wccp web-cache routers
- E. show ip wccp web-cache redirect out

Answer: C

Question No : 65

The command Rip v2 broadcast is used:

- A. To allow rip v2 broadcasts to be sent as broadcast packets instead of multicast packets
- B. To send RIP broadcasts as unicast packets instead of multicast packets
- C. To suppress rip v1 broadcasts
- D. Both a and c

Answer: A

Question No : 66

The ATM reference model is composed of which ATM layers? (multiple answer)

- A. ATM layer
- B. Physical layer
- C. Modular layer
- D. ATM adaptation layer

Answer: A,B,D

Question No : 67

What is the best definition of the use of "Area 0" in OSPF?

- A. Area 0 is used for administrative reasons, and is restricted from user definition.
- B. Area 0 is defined as the backbone, designed to be at the center of all routing updates,

and controls the dissemination of updates between areas.

C. Area 0 is used to authenticate messages received from other routers in the same area.

D. Area 0 is used for forwarding all routing updates received within the same Autonomous System from directly connected areas

only.

E. Area 0 allows for routing updates to be forwarded between different Autonomous Systems.

Answer: B

Question No : 68

Click the Exhibit button.

In the shown diagram, ServiceA and ServiceB are configured with a default gateway of 10.1.0.1. In order to load balance traffic to the content rule:

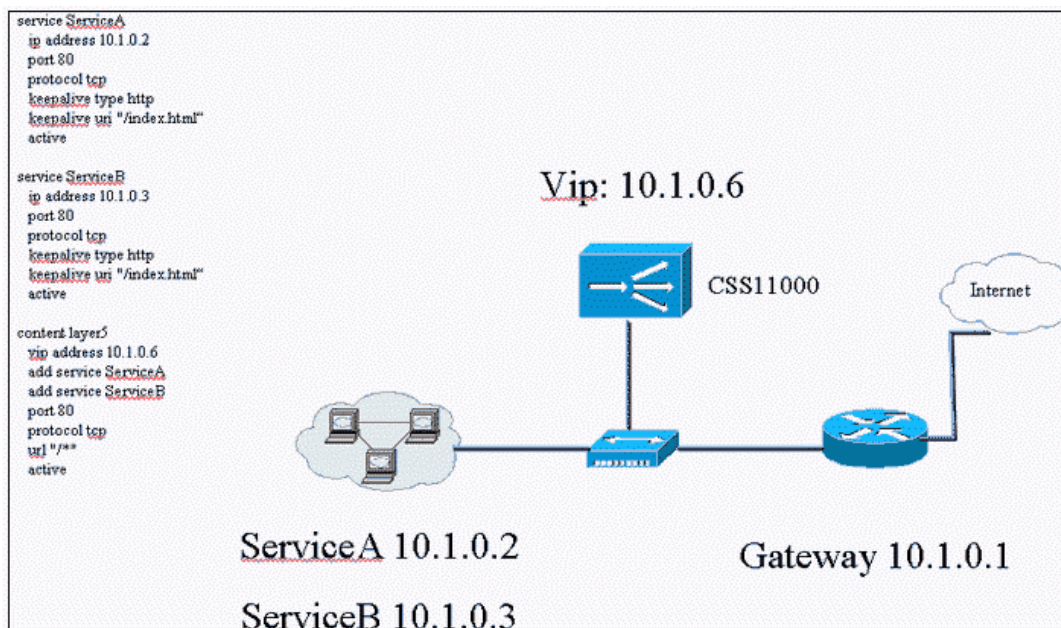

A. A source group must be configured with both services listed as 'add destination service.'

B. A source group must be configured with both services listed as 'add service.'

C. The CSS needs no additional configuration.

D. ACLs must be configured to permit load balancing.

Answer: A

Question No : 69

Click the Exhibit to view the topology.

Router A has a 512K-access port into the frame relay cloud. Router B has 128K-access port into the frame relay cloud. The two routers are connected with symmetrical PVCs that are configured for 64K committed information rate (CIR). What Frame Relay Traffic Shaping map-class sub-command should be entered on Router A to prevent workstation A from overrunning the access port on Router B?

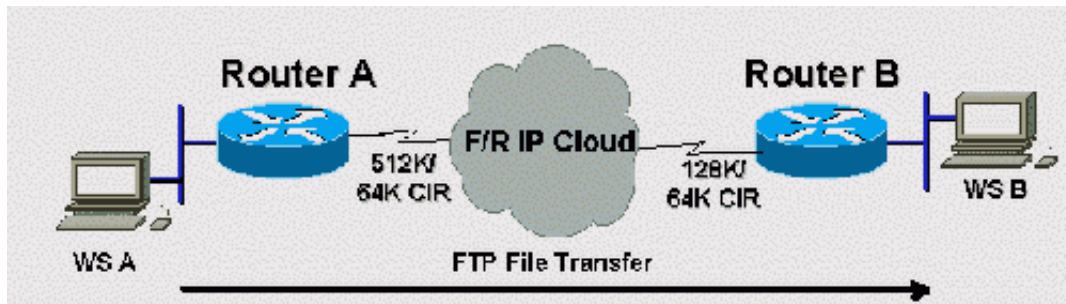

- A. frame-relay traffic-rate 128000 512000
- B. frame-relay traffic-rate 64000 512000
- C. frame-relay traffic-rate 512000 64000
- D. frame-relay traffic-rate 128000 64000
- E. frame-relay traffic-rate 64000 128000

Answer: E

Question No : 70

The web server of www.foo.com has updated several images on its web page. However, the web page seen by the user still shows the old images. In a sniffer trace taken at the user PC, what message would confirm the observed problem?

- A. HTTP HTTP/1.1 200 OK
- B. TCP 80 > 1681 [FIN,ACK]
- C. Date: Fri, 20 Oct 2000 11:48:52 GMT
Last-Modified: Wed, 20 Oct 1999 15:41:49 GMT
- D. Cache-Control: no-store, no-cache, must-revalidate
Pragma: no-cache
- E. Date: Fri, 20 Oct 2000 11:48:52 GMT
Last-Modified: Fri, 20 Oct 2000 11:48:52 GMT

Answer: C

Question No : 71

Click the Exhibit button to view the configuration.

What effect will this configuration command have?

line vty 0 4

no password vtypassword

A company has been assigned the Class B address of 191.8.0.0 by the NIC. They have decided to use a subnet mask of 255.255.255.0 and an autonomous system number of 1.

The configuration for Router A is as follows:

```
RouterA#show running-config
Current configuration:
version 11.3
1.) hostname RouterA
2.) enable-password enablepassword
3.) interface ethernet 0
4.) ip address 191.8.1.1 255.255.255.0
5.) no mop enabled
6.) interface serial 0
7.) ip address 191.8.150.1 255.255.255.0
8.) ip name-server 255.255.255.255
9.) ip host RouterB 191.8.150.2 191.8.2.1
10.) snmp-server community ccie
11.) line vty 0 4
12.) login
13.) line con 0
14.) line aux 0
15.) line vty 0
16.) password vtypassword
17.) line vty 1
18.) password vtypassword
19.) line vty 2
20.) password vtypassword
21.) line vty 3
22.) password vtypassword
23.) line vty 4
24.) password vtypassword
25.) end
RouterA#
```

The configuration for Router B is as follows:

```
RouterB#show running-config
Current configuration:
version 11.3
1.) hostname RouterB
2.) enable-password san-fran
3.) interface tokenring 0
4.) ip address 191.8.2.1 255.255.255.0
5.) ring-speed 16
6.) interface serial 0
7.) ip address 191.8.150.2 255.255.255.0
8.) ip name-server 255.255.255.255
9.) ip host A 191.8.2.1 191.8.150.1
10.) snmp-server community ccie
11.) logging buffered
12.) line vty 0 4
13.) login
14.) line con 0
15.) line aux 0
16.) line vty 0
17.) password cisco
18.) line vty 1
19.) password cisco
20.) line vty 2
21.) password cisco
22.) line vty 3
23.) password cisco
24.) line vty 4
25.) password cisco
26.) end
RouterB#
```

- A. All telnet connections to the router will be denied.
- B. Only one telnet connection at the router will be allowed at a time.
- C. Virtual terminal sessions will not be able to enter enable mode.
- D. Virtual terminal sessions will not be asked a user-level password.
- E. It will have no effect.

Answer: A

Question No : 72

Given an address of 10.1.1.1 with a subnet mask of 255.255.255.224, how many hosts can be addressed in this subnet?

- A. 16
- B. 15
- C. 30
- D. 31

E. 63

Answer: C

Question No : 73

Which HTTP header attributes can CSG report for billing or accounting?

- A. URL
- B. Hostname
- C. Can be configured to report any header value
- D. Can be configured to report any header value from the client to the server
- E. None of the above

Answer: D

Question No : 74

What is the primary benefit of the "time-to-live" field in the IP header?

- A. To improve buffer utilization
- B. To reduce the impact of routing loops
- C. To allow calculation of round-trip delays
- D. To remind us that all earthly joys are fleeting
- E. To avoid delivery of packets that are no longer useful

Answer: B

Question No : 75

In the SSL handshake, how is the cipher suite negotiated?

- A. The client sends a list of supported cipher suites, and the server must select the first one on that list it supports.
- B. The client and the server take turns in sending proposals back and forth, until they agree on a cipher suite or have exhausted their supported cipher suite lists.
- C. The client sends the cipher suite it wants to use; the server has to support all cipher suites.

D. The server sends the cipher suite it wants to use; the client has to support all cipher suites.

E. The client sends a list of supported cipher suites, and the server selects the cipher suite it wants to use.

Answer: E

Question No : 76

What Q.931 message cannot be received in response to sending a Q.931 SETUP message?

A. Alerting

B. Call Proceeding

C. Connect

D. USER Information

E. Progress

Answer: D

Question No : 77

What statement true about HTTPS?

A. Web traffic is carried over a separate protocol, unrelated to the original HTTP protocols. This new protocol is HTTPS.

B. Secure protocols such as tunnel encryption methods are carried over plaintext HTTP.

C. It is a mechanism for encrypting the HTTP protocol bodies while the keeping the HTTP protocol headers in cleartext.

D. It uses plaintext HTTP over an encrypting protocol, such as TLS.

Answer: D

Question No : 78

In HTTP 1.1 there is a CONNECT method defined in the RFC. What is the purpose of this method?

A. To allow a system administrator to manage the cache via HTTP or HTTPS

-
- B. For a user's browser to set up an HTTPS tunnel to proxy server
 - C. To allow transparent ftp redirection
 - D. For a user's browser to set up an FTP tunnel to an origin server and tell an upstream proxy to tunnel the response
 - E. For a user's browser to tell a proxy to connect to an origin server and tunnel the following communications to and from the user

Answer: E

Question No : 79

Within a Content Delivery Network there are 3 ways to get a client to the closest Content Engine for delivery of Content. One way is using Simplified Hybrid Routing. The other 2 ways are:

- A. Using WCCP on a router for transparent redirection or setting the proxy settings in a browser point to the closest Content Engine.
- B. Using WCCP on a router for transparent redirection or using DNS to resolve to the correct Content Engine.
- C. Using DNS to direct the request to a content router and using a HTTP redirect to have the client go directly to the Content Engine.
- D. Using a Coverage Zone file on the client and then using an HTTP redirect to have the client redirect to the closest Content Engine.
- E. Setting up proxy settings in a browser pointing to the closest CE or using DNS to provide the IP address of the closest CE.

Answer: A

Question No : 80

Click the Exhibit button to view the routing table.

A router has the above routes listed in its routing table and receives a packet destined for 172.16.0.45. What will happen?

```
S* 0.0.0.0/0 [1/0] via 172.31.116.65
D 172.16.0.0/24 [90/48609] via 10.1.1.1
R 172.16.0.0/16 [120/4] via 192.168.1.4
```

- A. The router will not forward this packet, since it is destined for the 0 subnet.
- B. The router will forward the packet through 172.31.116.65, since it has the lowest metric.
- C. The router will forward the packet through 10.1.1.1.
- D. The router will forward the packet through 172.31.116.65, since it has the lowest administrative distance.
- E. The router will forward the packet through 192.168.1.4.

Answer: C

Question No : 81

The two label distribution protocols that provide support for MPLS traffic engineering are:

- A. RSVP and OSPF
- B. CR-LDP and IBGP
- C. RSVP and CR-LDP
- D. LPS and LDS

Answer: C

Question No : 82

Click the Exhibit button to view the topology.

What mechanism should be employed to limit the "transmit rate" from Router A to Router C?

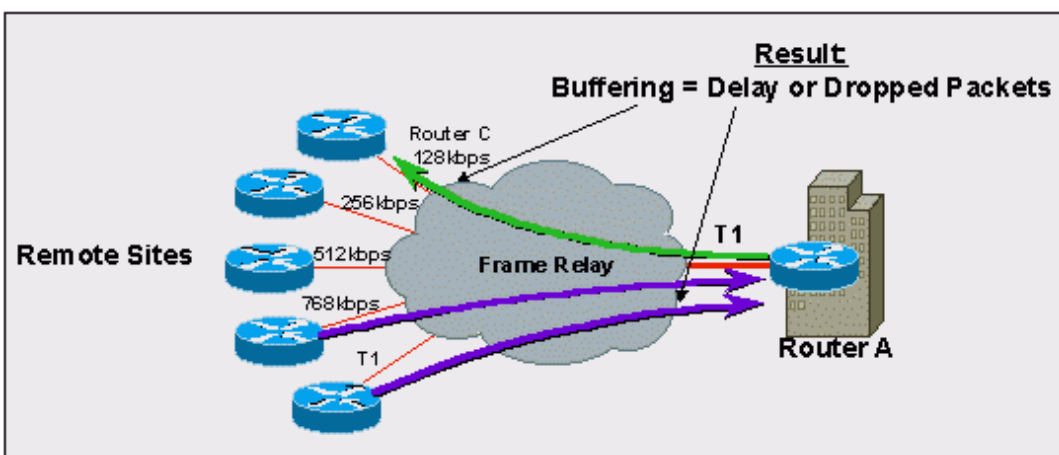

- A. Committed Access Rate
- B. Traffic Shaping
- C. Weighted Fair Queuing

-
- D. Packet Classification w/ Weighted Fair Queuing
 - E. None of the Above

Answer: B

Question No : 83

What is NOT a reason to deploy MPLS?

- A. Ubiquitous acceptance and firm standards
- B. Traffic engineering capabilities
- C. Simplify lookups in software-based routers
- D. Potential use in VPN services

Answer: A

Question No : 84

Click the Exhibit button to view the configuration. What statement is correct concerning the shown configuration?

```
interface eth 0
ip add 10.0.0.1 255.255.255.0

router rip
network 10.0.0.0
passive-interface ethernet 0
neighbor 10.0.0.2
```

- A. Two RIP updates will be sent out on Ethernet 0: one broadcast to 255.255.255.255 and one unicast to 10.0.0.2.
- B. Only one RIP update will be sent out on Ethernet 0 to the broadcast address 255.255.255.255, but no RIP updates will be received on Ethernet 0.
- C. Two RIP updates will be sent out on Ethernet 0, one broadcast to 10.255.255.255 and one unicast to 10.0.0.2.
- D. Only one RIP update will be sent out on Ethernet 0 to the unicast address 10.0.0.2.

Answer: D

Question No : 85

Click the Exhibit button. In the shown scenario, the inside VIP address is translated by the firewall into the external ip address 172.16.1.10. The CSS interface E1 IP address is translated into 172.16.1.2. If you want to check the status of the CSS VIP from the GSS using a keepalive of type KAL-AP, what type of configuration would be needed?

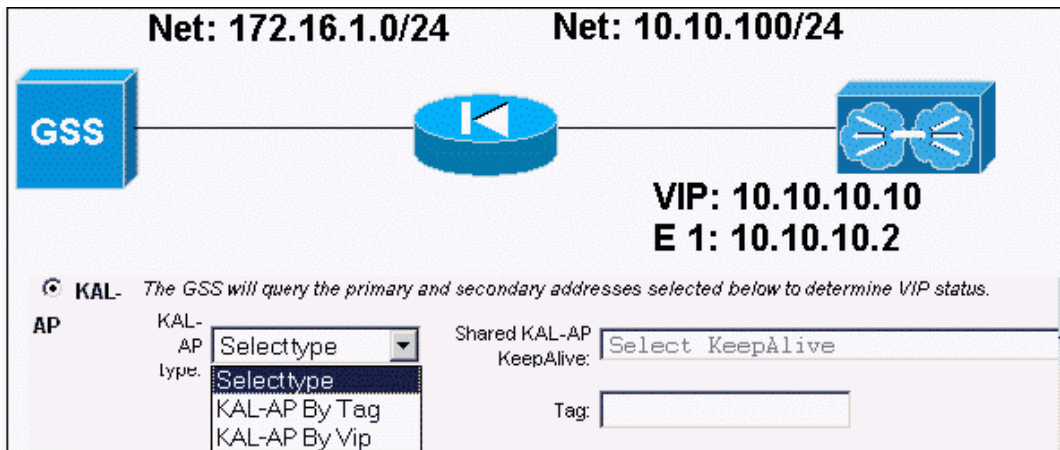

- A. KAL-AP by TAG with Shared KAL-AP of 172.16.1.2
- B. KAL-AP by VIP with Shared KAL-AP of 10.10.10.10
- C. KAL-AP by VIP with Shared KAL-AP of 172.16.1.10
- D. KAL-AP by VIP with Shared KAL-AP of 172.16.1.2
- E. KAP by TAG with Shared KAL-AP of 172.16.1.10

Answer: A

Question No : 86

Which resource records are necessary to perform subzone delegation on a DNS server?

- A. NS record and reverse record for the nameserver responsible for the subzone.
- B. NS record and MX record for the nameserver responsible for the subzone.
- C. MX record and A record for the nameserver responsible for the subzone.
- D. NS record and A record for the nameserver responsible for the subzone.
- E. NS record and SOA record for the nameserver responsible for the subzone.

Answer: D

Question No : 87

The purpose of Administrative Distance, as used by Cisco routers, is:

- A. To choose between routes from different routing protocols when receiving updates for the same network
- B. To identify which routing protocol forwarded the update
- C. To define the distance to the destination used in deciding the best path
- D. To be used only for administrative purposes

Answer: A

Question No : 88

Click the Exhibit button. In the shown diagram, for the content switch module, the default gateway of the web servers should be:

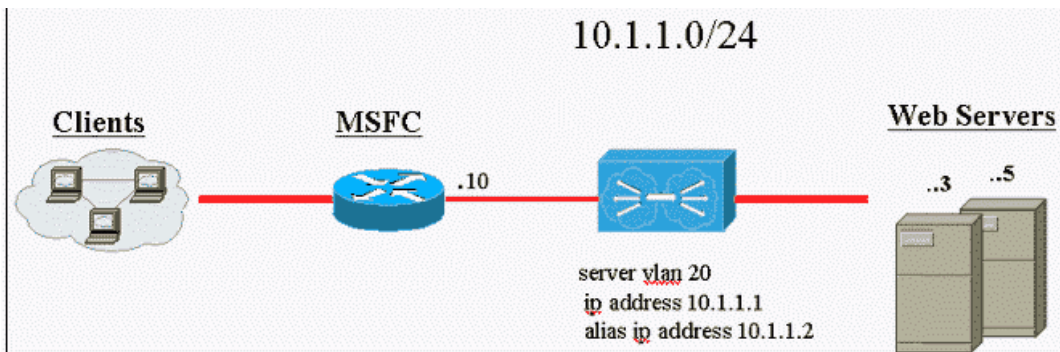

- A. server vlan ip address 10.1.1.1
- B. server vlan alias ip address 10.1.1.2
- C. Interface vlan 10 ip address 10.1.1.10
- D. None of the above

Answer: C

Question No : 89

What statement regarding an SSL transaction is NOT correct?

- A. An SSL transaction begins with an SSL handshake where the client and server negotiate encrypted communication.
- B. Both the TCP and IP headers are encrypted in order to prevent a third party from seeing the contents of the communication.
- C. SSL can be used to encrypt different protocols including, HTTP, FTP, and Mail.
- D. Secure Sockets Layer (SSL) is an application-level protocol that provides encryption technology for the Internet, ensuring secure

transactions such as the transmission of credit card numbers for e-commerce Web sites.

Answer: B

Question No : 90

This is the CSS11000 configuration. www.foo.com resolves to the IP address 80.80.80.80
content rule1 protocol tcp vip address 80.80.80.80 port 80 url "/"* add service web3 add
service web4 active content rule2 protocol tcp vip address 80.80.80.80 port 80 url
"/question/*" add service web1 add service web2 active A web page is not returned from
application on web servers web1 and web2. The URL the client is requesting
(http://www.foo.com) resides on web1 and web2. What configuration change is required to
return the correct page?

- A. content rule1
url "//www.foo.com/*"
- B. content rule2
url "//www.foo.com/question/*"
- C. content rule1
url "//www.foo.com/picture/*"
- D. content rule2
url "/picture/*"
- E. content rule1E.content rule1
No url

Answer: D

Question No : 91

GET / HTTP/1.1\r\n Connection: Keep-Alive\r\n User-Agent: Mozilla/4.8 [en]C-CCK-MCD
(Windows NT 5.0; U)\r\n Host: www.cisco.com\r\n Accept: image/gif, image/x-xbitmap,
image/jpeg, image/pjpeg, image/png, */*\r\n Accept-Encoding: gzip\r\n Accept-Language:
en\r\n Accept-Charset: iso-8859-1,*,utf-8\r\n In the above listed HTTP request, which lines
are required (by RFC) for an HTTP 1.1 request?

- A. "GET / HTTP/1.1\r\n" and "User-Agent: Mozilla/4.8 [en]C-CCK-MCD (Windows NT 5.0; U)\r\n"
- B. "GET / HTTP/1.1\r\n", "Host: www.cisco.com\r\n" and "Accept-Language: en\r\n"
- C. "GET / HTTP/1.1\r\n"
- D. "GET / HTTP/1.1\r\n" and "Host: www.cisco.com\r\n"
- E. All lines are required

Answer: D

Question No : 92

What is the WCCP Service Group number for Reverse Proxy?

- A. 80
- B. 90
- C. 82
- D. 99
- E. 0

Answer: D

Question No : 93

Click the Exhibit button. In the shown diagram how does WCCP on the router decide which cache to send a request from the user?

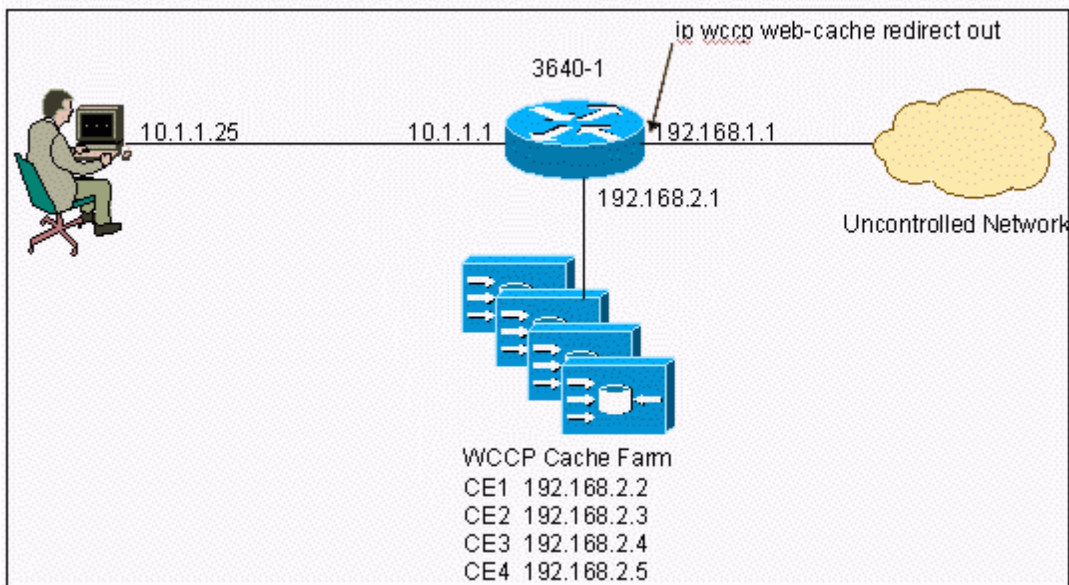

- A. It randomly selects a cache.
- B. It uses the source address of the request and hashes to a cache.
- C. It uses the destination address of the request and hashes to a cache.
- D. It uses the source and destination address of the request and hashes to a cache.
- E. It uses the source port of the request and hashes that to a cache.

Answer: C

Question No : 94

Click the Exhibit button to view the topology. L3 switches R1 and R2 are in the backbone of the network. They are connected by a routed EtherChannel bundle consisting of eight Gigabit Ethernet ports. The routed link is represented as subnet X.0 in the diagram. Since X.0 is routed, it is not a VLAN trunk. How can spanning tree loops be prevented in the backbone of this network?

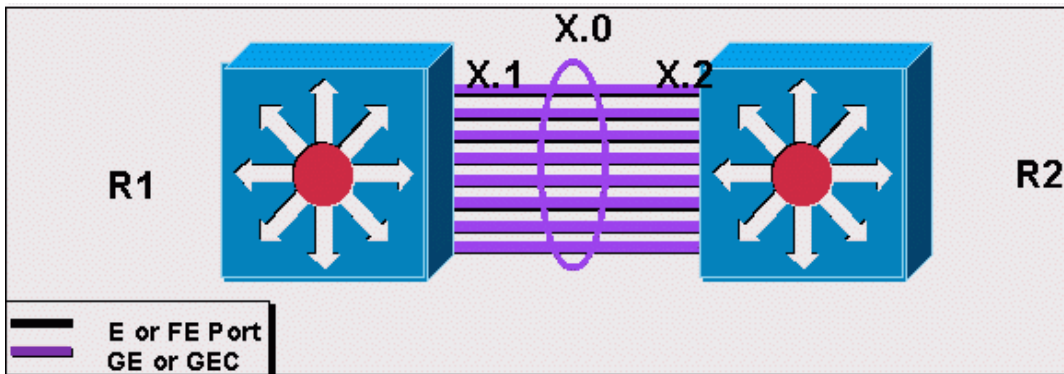

- A. Since EtherChannel X is routed there are no spanning tree loops.
- B. Configure seven of the eight ports in the bundle as passive interfaces
- C. Configure UplinkFast on R1 and R2
- D. Disable Spanning Tree Protocol (STP) on R1 and R2
- E. Disable VLAN X on seven of the eight ports in the bundle

Answer: A

Question No : 95

Please refer to the following line from a content engine transaction log. 1012429341.115 100 172.16.100.152 TCP_REFRESH_MISS/304 1100 GET http://www.cisco.com/images/homepage/news.gif - DIRECT/www.cisco.com Whats does the 304 mean in this log?

- A. The complete content was retrieved from the origin server.
- B. The complete content was served out of the cache.
- C. An If-modified-since request was sent from the client and the complete content was sent back to the client.
- D. An If-modified-since request was sent from the client and a not modified response code was sent back to the client.
- E. 304 bytes of data was sent back to the client.

Answer: D

Question No : 96

How long is an ATM cell header?

- A. 5 octets (bytes)
- B. 3 octets (bytes)
- C. 8 octets (bytes)
- D. The size varies by AAL type used

Answer: A

Question No : 97

Click the Exhibit button. When loadbalancing TACACS+, the loadbalancer needs to:

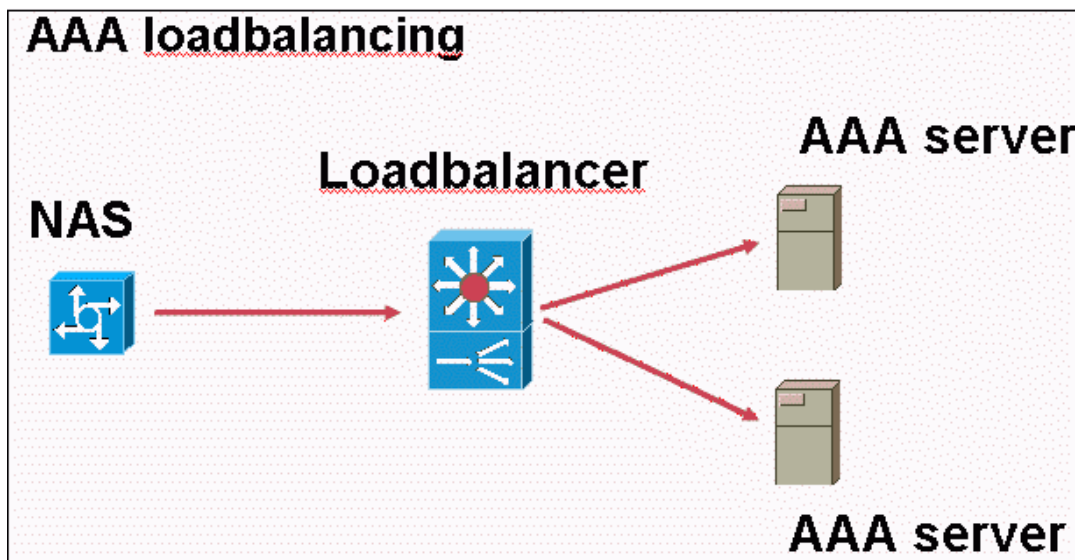

- A. Loadbalance UDP traffic on port 1645, and TCP on port 49
- B. Loadbalance TCP traffic on ports 1645 and 1812.
- C. Be TACACS+-aware and loadbalance on TCP port 49.
- D. Loadbalance TCP traffic on port 49.
- E. Be TACACS+-aware and loadbalance on UDP traffic on port 49.

Answer: D

Question No : 98

How is it possible to allow servers to be directly accessed when they are being load balanced through the CSM in routed mode?

- A.** Create a vserver with a virtual IP address of 0.0.0.0 and have a static route point to the CSM's server side VLAN for traffic destined to the servers. Include predictor forward and no nat client in the server farm.
- B.** Create a vserver with a virtual IP address of the server and have a static route point to the CSM's client side VLAN for traffic destined to the servers. Include predictor forward and no nat server in the server farm.
- C.** Create a vserver with a virtual IP address of 0.0.0.0 and have a static route point to the CSM's server side VLAN for traffic destined to the servers. Include predictor forward and nat client in the server farm.
- D.** Create a vserver with a virtual IP address of 0.0.0.0 and have a static route point to the CSM's client side VLAN for traffic destined to the servers. Include predictor forward and nat client in the server farm.

Answer: B

Question No : 99

Click the Exhibit button to view the topology. In the MPLS network shown, how many routing tables are on Router A?

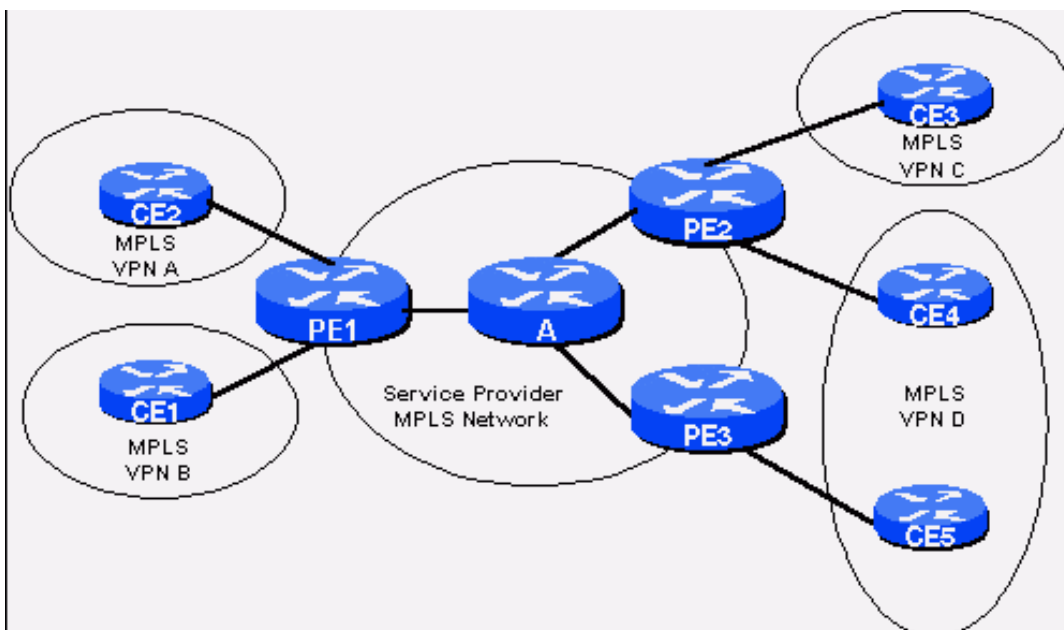

- A. 1
- B. 2
- C. 3
- D. 4
- E. 5

Answer: A

Question No : 100

What is the difference between pre-positioned and pre-loaded content in an ACNS 5.X Content Delivery Network?

- A.** Pre-loaded content is content that has been fetched by the root Content Engine and distributed to all the Content Engines.
Pre-positioned content is content that all Content Engines fetch independently from an origin server.
- B.** Pre-loaded content is content that has been fetched by the Content Distribution Manager and distributed to all the Content Engines. Pre-positioned content is content that all Content Engines fetch independently from an origin server.
- C.** Pre-positioned content is content that has been fetched by the root Content Engine and distributed to all the Content Engines.
Pre-loaded content is content that all Content Engines fetch independently from an origin server.
- D.** Both are exactly the same and do the same function.
- E.** Pre-positioned content is content that has been fetched by the Content Distribution Manager and distributed to all the Content Engines. Pre-loaded content is content that all Content Engines fetch independently from an origin server.

Answer: C

Question No : 101

Which HTTP header attributes can CSG report for billing or accounting?

- A.** URL
- B.** Hostname
- C.** Can be configured to report any header value
- D.** Can be configured to report any header value from the client to the server
- E.** None of the above

Answer: D

Question No : 102

What describes a technique, used to encapsulate voice (NOT data) over ATM?

- A. RFC 1483
- B. LANE
- C. AAL-1
- D. RFC 1577

Answer: C

Question No : 103

In HTTP 1.1 there is a CONNECT method defined in the RFC. What is the purpose of this method?

- A. To allow a system administrator to manage the cache via HTTP or HTTPS
- B. For a user's browser to set up an HTTPS tunnel to proxy server
- C. To allow transparent ftp redirection
- D. For a user's browser to set up an FTP tunnel to an origin server and tell an upstream proxy to tunnel the response
- E. For a user's browser to tell a proxy to connect to an origin server and tunnel the following communications to and from the user

Answer: E

Question No : 104

Click the Exhibit button to view the configuration. In the diagram shown, what mechanism needs to be employed on the remote site routers to aid congestion avoidance in the core, based on traffic priorities?

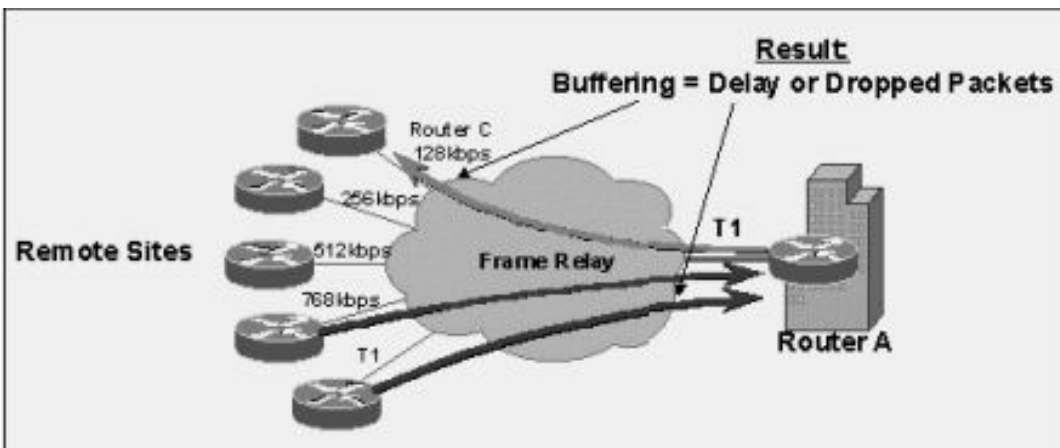

- A. IP Precedence Tagging
- B. Weighted Random Early Detection

- C. Random Early Detection
- D. Class Based Weighted Fair Queuing

Answer: A

Question No : 105

What is the default port number is used by Cisco's Content Engine Windows Media Server for streaming data via UDP?

- A. 80
- B. 1755
- C. 8001
- D. 554
- E. 17

Answer: B

Question No : 106

Click the Exhibit button to view the topology. Host D sends a frame to Host B at the same time that Host B sends a frame to Host D. Bridging is enabled on Router 1, and the two frames collide into each other. Select the best explanation of why Host B will or will not receive the original frame from Host D:

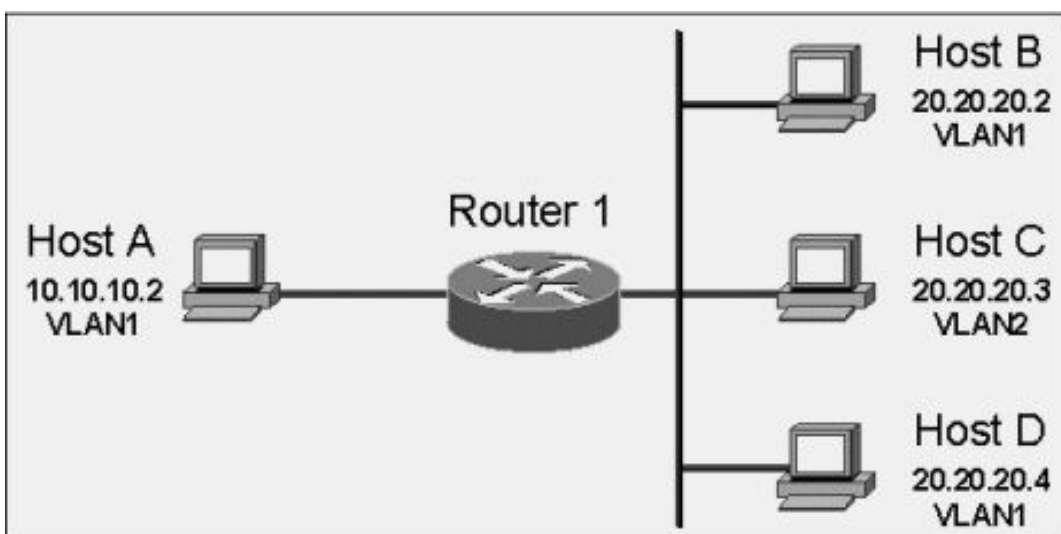

- A. Host B will receive the frame, since Hosts B and D are in the same VLAN.
- B. Host B will receive the frame, since Hosts B and D are in the same routing domain.
- C. Host B will not receive the frame, since Hosts B and D are in the same collision domain.

- D. Host B will not receive the frame, since Hosts B and D are in different broadcast domains.
- E. Host B will receive the frame, since Hosts B and D are in the same bridging domain.

Answer: C

Question No : 107

Click the Exhibit button. In the shown diagram, the Cisco Cache Engines are configured in a reverse proxy fashion. On the CSS, for what type of service must the cache engines be configured?

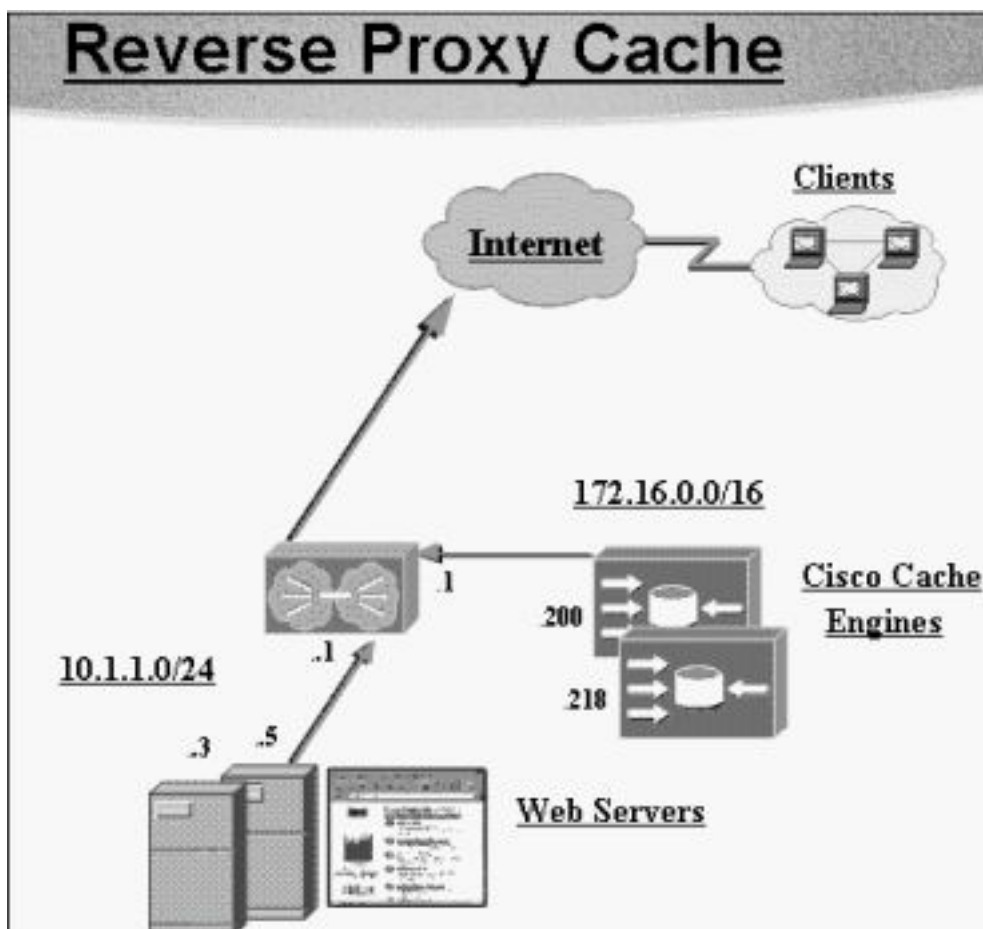

- A. Type transparent-cache
- B. Type proxy-cache
- C. Type local
- D. Type redirect
- E. No type needs to be specified

Answer: A

Question No : 108

Click the Exhibit button to view the topology. The diagram shows a campus with a L2 switched backbone. The backbone has a single VLAN (= subnet) with no loops. The links into the backbone are routed interfaces, not VLAN trunks. Switch X is the STP root of the core VLAN and switch Y is the standby root. The connection between X and Y is an EtherChannel. The network architect wants to add more redundancy by connecting the L3 switches in the distribution layer to both X and Y. What best describes that plan?

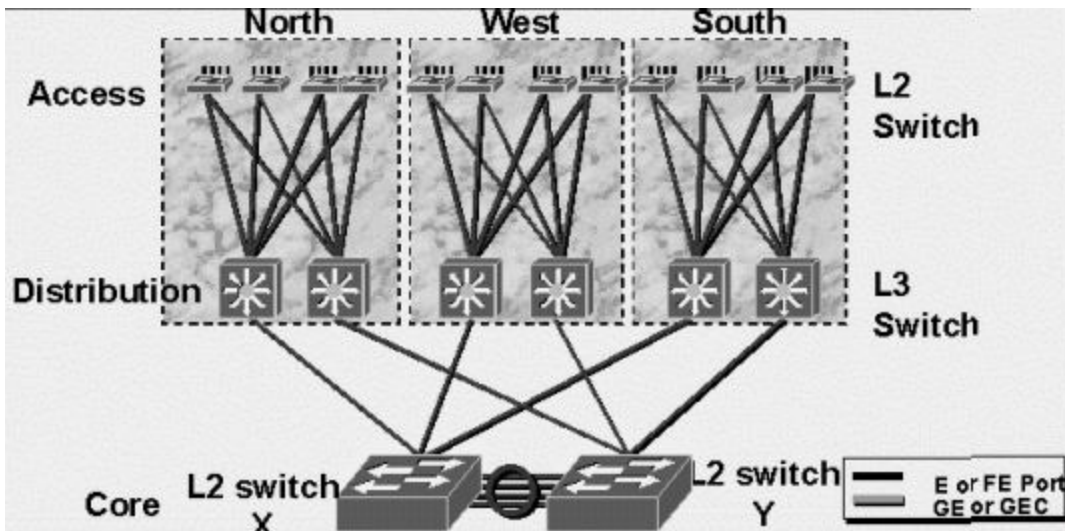

- A. It is a sound idea because it increases bandwidth and redundancy.
- B. It is not sound financially because the extra links will be blocking.
- C. It will cause loops that STP cannot resolve.
- D. It is impossible because routers cannot have two interfaces on the same subnet.
- E. It is a sound idea because packets take a single L2 hop across the backbone.

Answer: D

Question No : 109

To restrict SNMP access to a router, what configuration command could be used?

- A. `snmp-server community`
- B. `snmp-server enable`
- C. `snmp-server log`
- D. `snmp-server host`

Answer: A

Question No : 110

To configure a CSS in box-to-box redundancy, the circuit VLAN that runs VRRP must have what command configured?

- A. interface-redundant
- B. redundant-circuit
- C. redundancy-protocol
- D. circuit-redundant
- E. redundancy-interface

Answer: C

Question No : 111

How does Transport Layer Security (TLS) differ from SSLv3?

- A. TLS supports Diffie-Hellman ciphers and SSLv3 does not.
- B. The way they derive keys from the master secret.
- C. TLS supports client authentication and SSLv3 does not.
- D. The way in which the Session ID is computed.
- E. All of the above

Answer: B

Question No : 112

What is the best definition of the use of "Area 0" in OSPF?

- A. Area 0 is used for administrative reasons, and is restricted from user definition.
- B. Area 0 is defined as the backbone, designed to be at the center of all routing updates, and controls the dissemination of updates between areas.
- C. Area 0 is used to authenticate messages received from other routers in the same area.
- D. Area 0 is used for forwarding all routing updates received within the same Autonomous System from directly connected areas only.
- E. Area 0 allows for routing updates to be forwarded between different Autonomous Systems.

Answer: B

Question No : 113

Click the Exhibit button to view the topology. In the MPLS network shown, how many routing tables are on Router PE1?

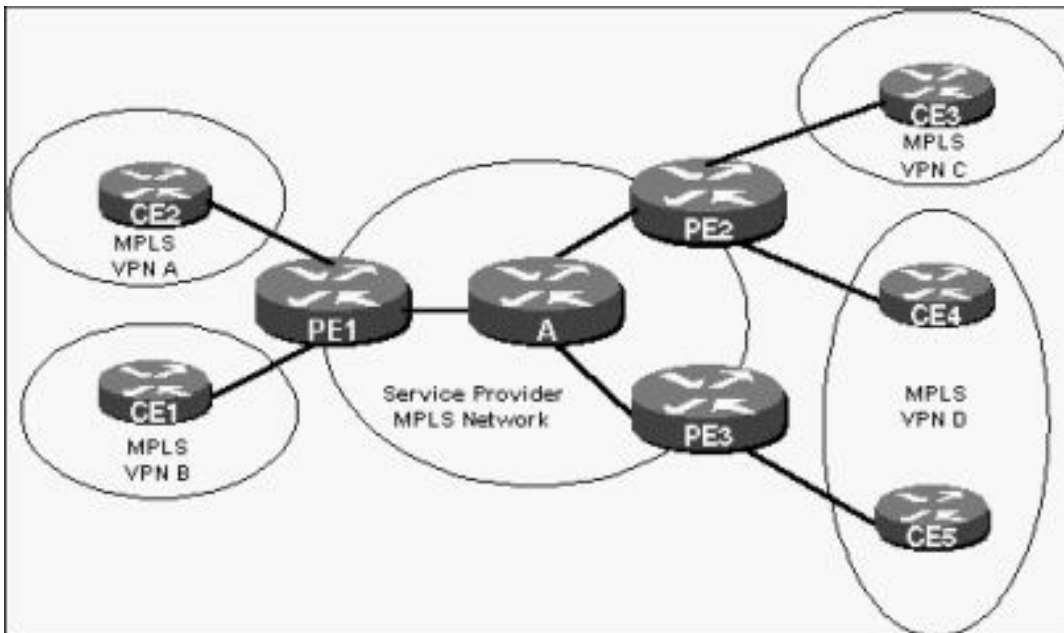

- A. 1
- B. 2
- C. 3
- D. 4
- E. 5

Answer: C

Question No : 114

Click the Exhibit button. In the shown diagram, for the content switch module, the default gateway of the web servers should be:

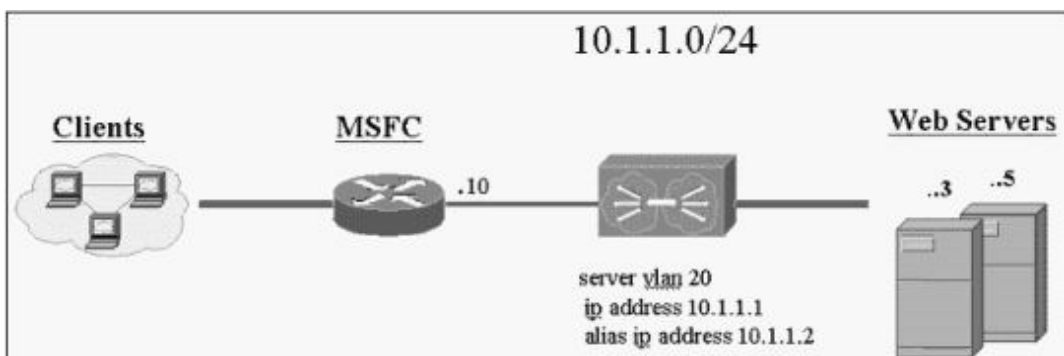

- A. server vlan ip address 10.1.1.1

-
- B. server vlan alias ip address 10.1.1.2
 - C. Interface vlan 10 ip address 10.1.1.10
 - D. None of the above

Answer: C

Question No : 115

A router is set to boot from flash, but cannot find boot commands in the configuration. Also, valid files do not exist in the default flash device. The router will:

- A. Boot from ROM, since there are no valid sources
- B. Try to boot from the network, using a default filename
- C. Terminate the boot process with an error message
- D. Try to boot from the network, then boot from ROM as a backup

Answer: D

Question No : 116

How is Equal Cost Multipath Protocol configured on the CSS?

- A. ECMP command in the router service
- B. Global IP ECMP command
- C. VLAN1 IP ECMP command
- D. ECMP command in a content rule
- E. VLAN1 enable ECMP command

Answer: B

Question No : 117

Telcordia has defined national ISDN, which is basically within the construct of Q.931 protocol with some modifications. If National ISDN requires a new information element (IE), how will this need be handled?

- A. No new IE can be defined by standard bodies other than ITU-T; therefore, Telcordia must pass the information in open fields of existing IE.

-
- B. Telcordia has to define a new codeset (CS) 0 IE.
 - C. Telcordia should define a new CS7 IE
 - D. Telcordia should define a new CS5 IE
 - E. Use CS8 IE

Answer: D

Question No : 118

In MPLS what is an LSP?

- A. Label Selection Pair
- B. Label Switched Path
- C. Lightweight Signaling Protocol
- D. Large Sampling Path

Answer: B

Question No : 119

Within a Content Delivery Network there are 3 ways to get a client to the closest Content Engine for delivery of Content. One way is using Simplified Hybrid Routing. The other 2 ways are:

- A. Using WCCP on a router for transparent redirection or setting the proxy settings in a browser point to the closest Content Engine.
- B. Using WCCP on a router for transparent redirection or using DNS to resolve to the correct Content Engine.
- C. Using DNS to direct the request to a content router and using a HTTP redirect to have the client go directly to the Content Engine.
- D. Using a Coverage Zone file on the client and then using an HTTP redirect to have the client redirect to the closest Content Engine.
- E. Setting up proxy settings in a browser pointing to the closest CE or using DNS to provide the IP address of the closest CE.

Answer: A

Question No : 120

Click the Exhibit button to view the topology. Host 1 and Host 2 are on Ethernet LANs in different buildings. A serial line is installed between two Cisco routers using Cisco HDLC serial line encapsulation. Routers A and B are configured to route IP traffic. Host 1 sends a packet to Host 2. A line hit on the serial line causes an error in the packet. When this is detected, the retransmission is sent by:

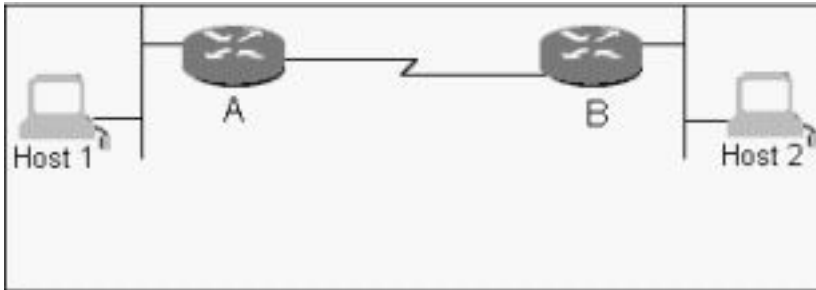

- A. Host 1
- B. Host 2
- C. Router A
- D. Router B
- E. Protocol analyzer

Answer: A

Question No : 121

Click the Exhibit button to view the configuration. Debug is enabled on Router B, but no debug messages appear on the terminal. Other commands (show commands, etc.) seem to be working. What are the probable causes for this? (multiple answer)

A company has been assigned the Class B address of 191.8.0.0 by the NIC. They have decided to use a subnet mask of 255.255.255.0 and an autonomous system number of 1.

The configuration for Router A is as follows:

```
RouterA#show running-config
Current configuration:
version 11.3
1.) hostname RouterA
2.) enable-password enablepassword
3.) interface ethernet 0
4.) ip address 191.8.1.1 255.255.255.0
5.) no mop enabled
6.) interface serial 0
7.) ip address 191.8.150.1 255.255.255.0
8.) ip name-server 255.255.255.255
9.) ip host RouterB 191.8.150.2 191.8.2.1
10.) snmp-server community ccie
11.) line vty 0 4
12.) login
13.) line con 0
14.) line aux 0
15.) line vty 0
16.) password vtypassword
17.) line vty 1
18.) password vtypassword
19.) line vty 2
20.) password vtypassword
21.) line vty 3
22.) password vtypassword
23.) line vty 4
24.) password vtypassword
25.) end
RouterA#
```

The configuration for Router B is as follows:

```
RouterB#show running-config
Current configuration:
version 11.3
1.) hostname RouterB
2.) enable-password san-fran
3.) interface tokenring 0
4.) ip address 191.8.2.1 255.255.255.0
5.) ring-speed 16
6.) interface serial 0
7.) ip address 191.8.150.2 255.255.255.0
8.) ip name-server 255.255.255.255
9.) ip host A 191.8.2.1 191.8.150.1
10.) snmp-server community ccie
11.) logging buffered
12.) line vty 0 4
13.) login
14.) line con 0
15.) line aux 0
16.) line vty 0
17.) password cisco
18.) line vty 1
19.) password cisco
20.) line vty 2
21.) password cisco
22.) line vty 3
23.) password cisco
24.) line vty 4
25.) password cisco
26.) end
RouterB#
```

- A. Router B is not turned on.
- B. Debug information is being sent to A.
- C. The "terminal monitor" command needs to be executed if this is a virtual terminal session.
- D. Debug information is being sent to the buffer instead of to the console terminal.
- E. Debug information is configured at low priority, and will be displayed at a time when the router is less congested.

Answer: C,D

Question No : 122

Click the Exhibit button to view the topology. The diagram shows a collapsed L3 switched building backbone consisting of two L3 switches: W and U. Each L3 switch has a routed interface on every subnet (VLAN) in the building. There are no VLAN trunks in the network. In other words the L3 switches are acting as native routers. There are exactly 4 client-side VLANs (subnets): a, b, c, d. There are exactly 2 server-side VLANs (subnets): x and y. There is one routed link (Subnet e) connecting the L3 switches in the core. How many equal-cost paths to Subnet d does L3 Switch W keep in its routing table?

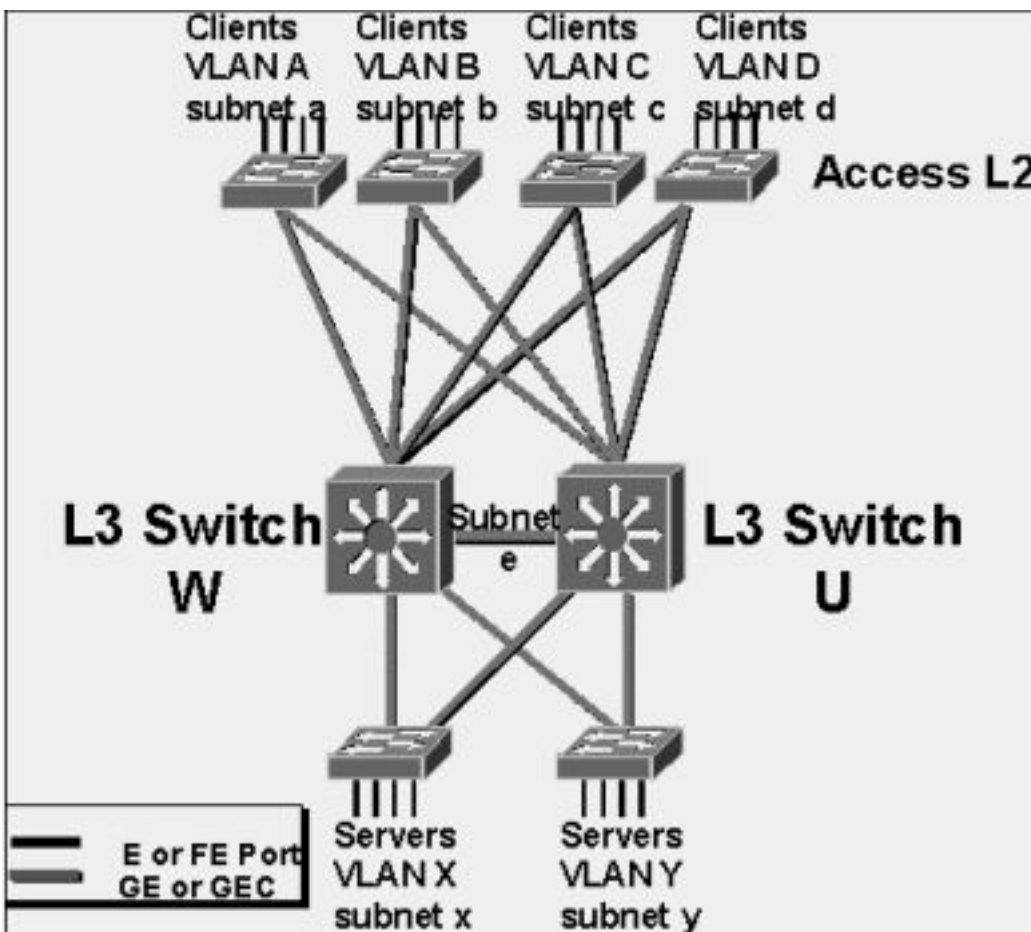

A. 1

-
- B. 2
 - C. 3
 - D. 4
 - E. 5

Answer: A

Question No : 123

How long is an ATM cell header?

- A. 5 octets (bytes)
- B. 3 octets (bytes)
- C. 8 octets (bytes)
- D. The size varies by AAL type used

Answer: A

Question No : 124

Which protocols are used to authenticate users?

- A. HMAC-MD5
- B. NTLM
- C. LDAP
- D. S/MIME
- E. Diffie-Hellman

Answer: B,C

Question No : 125

What statement regarding Network Qualifier Lists (NQL) is most correct?

- A. It is used to define a list of IP addresses and networks to simplify and enhance the implementation of ACLs.
- B. It is used to define a list of IP addresses to simplify and enhance the implementation of advanced balanced sticky source IP.
- C. It is used to define a list of IP addresses of hosts allowed SNMP access to a Content

Smart Switch.

D. It is used to define a list of IP addresses of FTP servers.

Answer: A

Question No : 126

Which three fundamental elements characterize the PKIs used in asymmetric cryptography?

- A. Confidentiality, authorization, message integrity
- B. Confidentiality, authentication, accounting
- C. Confidentiality, authentication, authorization
- D. Confidentiality, authentication, message integrity
- E. Authentication, authorization, accounting

Answer: D

Question No : 127

In box-to-box redundancy on the CSS, to configure an ip circuit (VLAN) as a redundant circuit, what command is used?

- A. Redundant-circuit
- B. Redundant-type-circuit
- C. Redundancy
- D. Redundancy-type-circuit
- E. None of the above

Answer: C

Question No : 128

It is desired to have the CSM match on the following URLs: /index.html /Index.html abc/index.html abc/Index.html What should be used?

- A. map TESTMAP url
match protocol http url */?ndex.html
- B. map TESTMAP url

match protocol http url */i*Index.html

C. map TESTMAP url

match protocol http url *ndex.html

D. map TESTMAP urlmatch protocol http url "*/ndex.html

Answer: A

Question No : 129

On a Cisco router running WCCP web-cache, what command will show the number of redirected packets?

A. show ip wccp web-cache redirect

B. show ip wccp web-cache view

C. show ip wccp web-cache detail

D. show ip wccp web-cache routers

E. show ip wccp web-cache redirect out

Answer: C

Question No : 130

Click the Exhibit button. Given the four networks listed, what valid summary address (below) contains the longest prefix?

```
10.1.1.0/24
10.1.3.0/24
10.1.14.64/26
10.1.5.192/30
```

A. 10.1.0.0/20

B. 10.1.0.0/16

C. 10.1.1.0/23

D. 10.1.16.0/19

E. These networks cannot be summarized.

Answer: A

Question No : 131

Click the Exhibit button to view the topology. Customers green and blue must communicate with each other. Which condition is required?

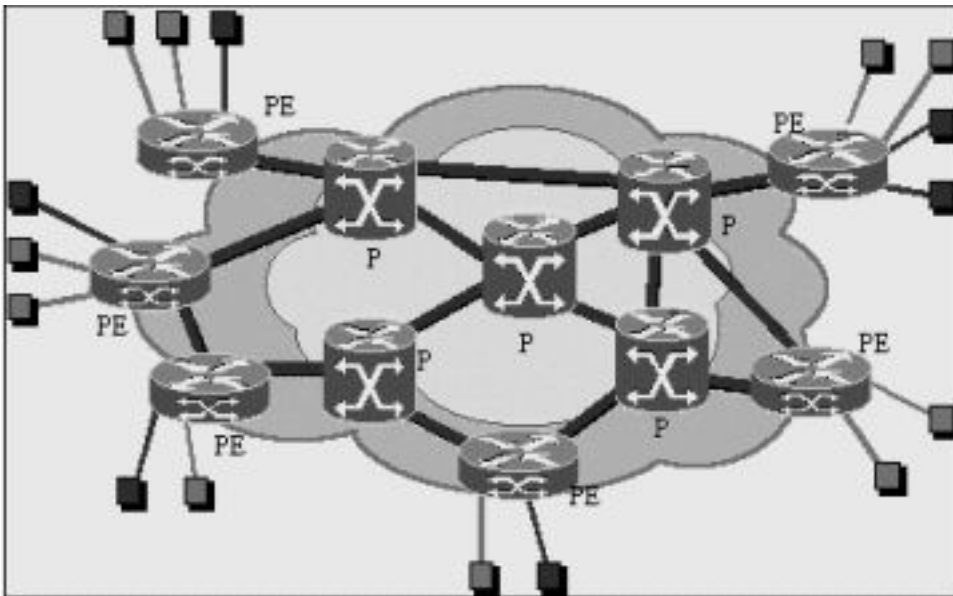

- A. Customer Blue and Customer Green must use BGP for routing to the Internet.
- B. Customer Blue and Customer Green must use unique addresses in their corporate networks.
- C. All Service Provider routers must use BGP.
- D. The Service Provider must provide BGP Peering to another Service Provider.

Answer: B

Question No : 132

Given an address of 10.1.1.1 with a subnet mask of 255.255.255.224, how many hosts can be addressed in this subnet?

- A. 16
- B. 15
- C. 30
- D. 31
- E. 63

Answer: C

Question No : 133

If the following url is put into a browser - ftp://ftp.cisco.com/ - what port does the browser

initially use to communicate to the origin server?

- A. 443
- B. 80
- C. 20
- D. 21
- E. 8080

Answer: D

Question No : 134

Click the Exhibit button to view the topology. In the MPLS network shown, which subnets would be in the same Forwarding Equivalence Class (FEC) on router PE1:

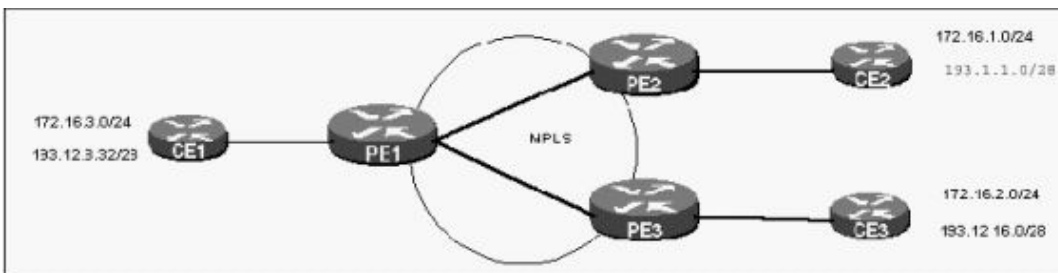

- A. 172.16.3.0/24 and 193.1.1.0/28
- B. 172.16.1.0/24 and 172.16.2.0/24
- C. 172.16.1.0/24 and 193.1.1.0/28
- D. 172.16.1.0/24, 172.16.2.0/24, and 172.16.3.0/24

Answer: C

Question No : 135

A router is set up to redistribute routing updates from OSPF to RIP. What answer best describes issues the network administrator needs to be aware of?

- A. Split Horizon, Poison Reverse, Holddown
- B. Slow convergence, limited hop-count metric, lack of network mask information, periodic broadcasts
- C. None, OSPF is a link-state routing protocol which overcomes issues found in RIP.
- D. Difference in metrics (e.g. hops vs. cost), subnet mask allocation/addressing (e.g. VLSM vs. fixed subnet mask length), routing protocol summarization (e.g. network boundaries)

Answer: D

Question No : 136

MPLS does not support:

- A. Multicast
- B. OSPF
- C. BGP
- D. Multicast and OSPF

Answer: A

Question No : 137

The website www.foo.com is having problems. The PC you are troubleshooting from does not have a web browser or sniffer software installed. Which method is the next best way to verify that the website will return the web page with content:

- A. tracert www.foo.com 80
- B. ping www.foo.com
- C. telnet www.foo.com 80
GET / HTTP/1.0
- D. telnet www.foo.com 80
- E. telnet www.foo.com 80
HEAD / HTTP/1.0

Answer: C

Question No : 138

What is the WCCP Service Group number for Reverse Proxy?

- A. 80
- B. 90
- C. 82
- D. 99
- E. 0

Answer: D

Question No : 139

What ISDN timer is started after Q.931 SETUP msg is sent?

- A. T301
- B. T303
- C. T302
- D. T310
- E. T305

Answer: B

Question No : 140

What is the difference between pre-positioned and pre-loaded content in an ACNS 5.X Content Delivery Network?

- A. Pre-loaded content is content that has been fetched by the root Content Engine and distributed to all the Content Engines.
Pre-positioned content is content that all Content Engines fetch independently from an origin server.
- B. Pre-loaded content is content that has been fetched by the Content Distribution Manager and distributed to all the Content Engines. Pre-positioned content is content that all Content Engines fetch independently from an origin server.
- C. Pre-positioned content is content that has been fetched by the root Content Engine and distributed to all the Content Engines.
Pre-loaded content is content that all Content Engines fetch independently from an origin server.
- D. Both are exactly the same and do the same function.
- E. Pre-positioned content is content that has been fetched by the Content Distribution Manager and distributed to all the Content Engines. Pre-loaded content is content that all Content Engines fetch independently from an origin server.

Answer: C

Question No : 141

Click the Exhibit button to view the topology. In a reorganization, OSPF areas are realigned. Is this a valid network design? If not, which changes could be made to the network and/or router configurations? (multiple answer)

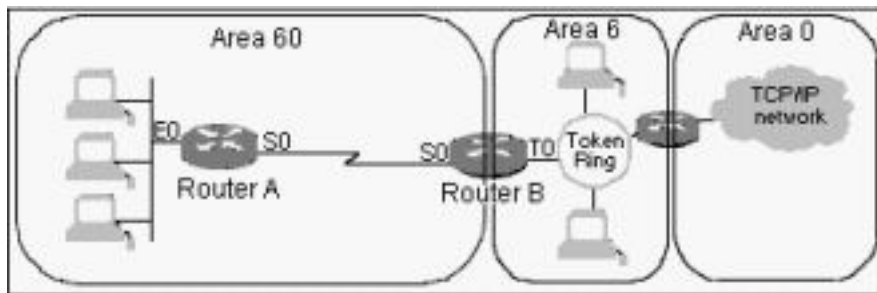

- A. No changes are necessary.
- B. A virtual link could be configured between Area 60 and Area 0.
- C. A serial line or other physical connection could be installed between devices in Area 60 and Area 0.
- D. Router B could be configured as an Area Border Router between Area 60 and Area 6.
- E. This is not a valid design, and no changes can make it work.

Answer: B,C

Question No : 142

Click the Exhibit button to view the topology. Using the above diagram, which are valid BGP AS_Path Attributes received at Net1 for a route originating from AS65100? (multiple answer)



- A. 200 57000 100 65100
- B. 200 57000 100 100
- C. 100 57000 200
- D. 200 57000 100
- E. 65100 100 57000 200

Answer: A,D,E

Question No : 143

Click the Exhibit button to view the configuration. What effect will this configuration command have? line vty 0 4 no password vtypassword

A company has been assigned the Class B address of 191.8.0.0 by the NIC. They have decided to use a subnet mask of 255.255.255.0 and an autonomous system number of 1.

The configuration for Router A is as follows:

```
RouterA#show running-config
Current configuration:
version 11.3
1.) hostname RouterA
2.) enable-password enablepassword
3.) interface ethernet 0
4.) ip address 191.8.1.1 255.255.255.0
5.) no mop enabled
6.) interface serial 0
7.) ip address 191.8.150.1 255.255.255.0
8.) ip name-server 255.255.255.255
9.) ip host RouterB 191.8.150.2 191.8.2.1
10.) snmp-server community ccie
11.) line vty 0 4
12.) login
13.) line con 0
14.) line aux 0
15.) line vty 0
16.) password vtypassword
17.) line vty 1
18.) password vtypassword
19.) line vty 2
20.) password vtypassword
21.) line vty 3
22.) password vtypassword
23.) line vty 4
24.) password vtypassword
25.) end
RouterA#
```

The configuration for Router B is as follows:

```
RouterB#show running-config
Current configuration:
version 11.3
1.) hostname RouterB
2.) enable-password san-fran
3.) interface tokenring 0
4.) ip address 191.8.2.1 255.255.255.0
5.) ring-speed 16
6.) interface serial 0
7.) ip address 191.8.150.2 255.255.255.0
8.) ip name-server 255.255.255.255
9.) ip host A 191.8.2.1 191.8.150.1
10.) snmp-server community ccie
11.) logging buffered
12.) line vty 0 4
13.) login
14.) line con 0
15.) line aux 0
16.) line vty 0
17.) password cisco
18.) line vty 1
19.) password cisco
20.) line vty 2
21.) password cisco
22.) line vty 3
23.) password cisco
24.) line vty 4
25.) password cisco
26.) end
RouterB#
```

- A. All telnet connections to the router will be denied.
- B. Only one telnet connection at the router will be allowed at a time.
- C. Virtual terminal sessions will not be able to enter enable mode.
- D. Virtual terminal sessions will not be asked a user-level password.
- E. It will have no effect.

Answer: A

Question No : 144

What statement regarding an SSL transaction is NOT correct?

- A. An SSL transaction begins with an SSL handshake where the client and server negotiate encrypted communication.
- B. Both the TCP and IP headers are encrypted in order to prevent a third party from seeing the contents of the communication.
- C. SSL can be used to encrypt different protocols including, HTTP, FTP, and Mail.
- D. Secure Sockets Layer (SSL) is an application-level protocol that provides encryption technology for the Internet, ensuring secure transactions such as the transmission of credit card numbers for e-commerce Web sites.

Answer: B

Question No : 145

The Hold-Down Timer used in Distance Vector protocols:

- A. Sets the time limit of how long a router may keep a packet in its buffer, if the routing protocol is in the process of converging
- B. Determines the number of seconds a router will wait before sending another update to neighbor routers
- C. Sets a specific period for routers to neither accept nor advertise a route from a destination where an original route was recently lost
- D. Sets a duration where routes are not accepted from the neighbor router that caused a routing loop

Answer: C

Question No : 146

Click the Exhibit button. In the shown diagram the two web servers are configured for port 81 and the content rule for port 80. If a client wishes to connect to the virtual IP address 172.16.0.100:

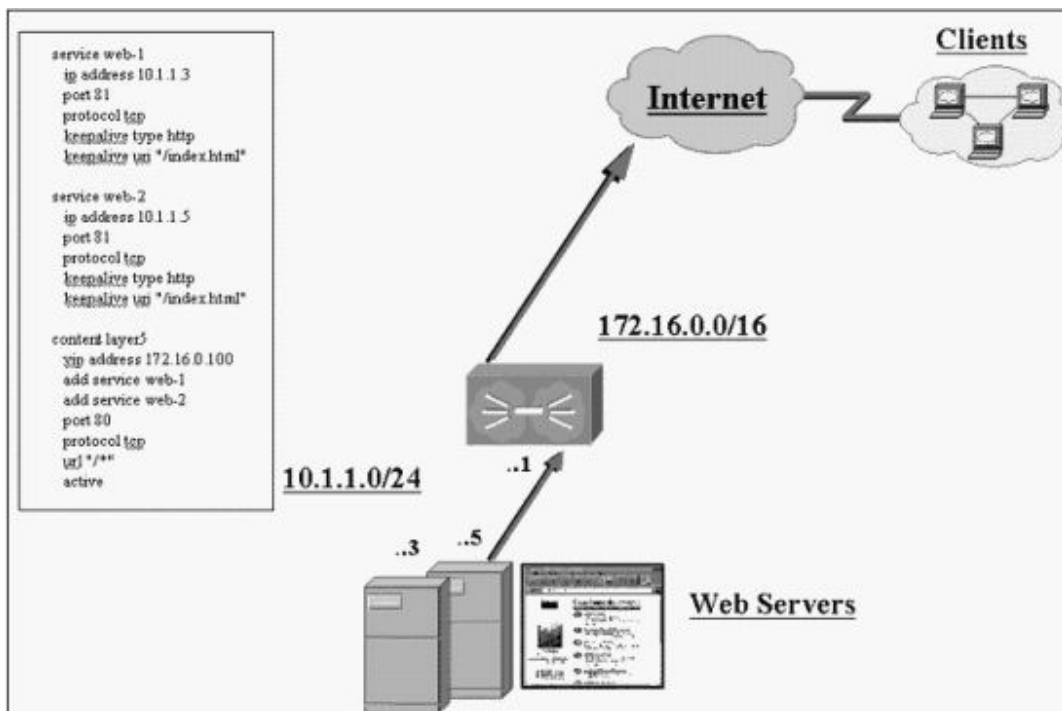

- A. A source group is needed to make this work properly.
- B. This configuration will work as configured.
- C. This configuration will not work.
- D. Access-lists must be configured to allow this to work.

E. DNS must be configured on the CSS for this to work properly.

Answer: C

Question No : 147

To maintain schema-consistency in an LDAP Directory Information Tree (DIT), the LDAP standard specifies that:

- A. The client first downloads the DIT schema from the server and then makes sure every request it sends conforms to the schema;
The server therefore doesn't have to check DIT for consistency
- B. The operator periodically scans the DIT to check that the schema is not violated, and manually corrects any inconsistencies caused by clients
- C. The server periodically scans the DIT to check that the schema is not violated, and sends a notification to the operator when it finds an inconsistency caused by clients
- D. The server periodically converts the DIT to an SQL database; Schema-checking is done by the SQL engine and then the database is converted back to a DIT
- E. The server checks every client operation for schema consistency, and ignores requests that would result in a DIT inconsistency

Answer: E

Question No : 148

What route selection options are available for ECMP in the CSS?

- A. Round Robin
- B. Weighted Round Robin
- C. Round Robin and Address Based
- D. Round Robin and Least Bandwidth
- E. Round Robin, Weighted Round Robin, and Address Based

Answer: C

Question No : 149

Click the Exhibit button to view the diagram. The address field contains: (multiple answer)

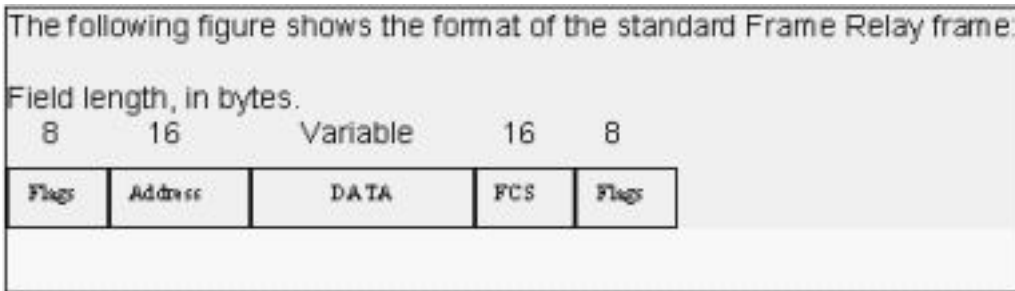

- A. The DLCI Value
- B. The Extended Address (EA)
- C. Congestion Control
- D. FCS

Answer: A,B,C

Question No : 150

When a proxy requires NTLM Authentication from a user and the system administrator does not want an authentication window to come up on the browser for the user to authenticate. The user must be:

- A. Using a Netscape browser, the windows domain controller configured on the CE and the user logged into the domain
- B. Using Internet Explorer, Radius configured on the CE and the user logged into the domain
- C. Using a Netscape browser, Websense configured on the CE and the user logged into a domain
- D. Using Internet Explorer, Windows Domain Controller configured on the CE and the user logged into the domain
- E. DNS, WINS, Internet Explore and TACACS configured on the CE, does not matter what browser is being used and the user logged into the domain

Answer: D

Question No : 151

WCCP is a communication protocol used between routers and cache devices. On what port does this protocol communicate?

-
- A. 80
 - B. 2180
 - C. 8080
 - D. 52
 - E. 2048

Answer: E

Question No : 152

How does TACACS+ implement AAA?

- A. Authentication, Authorization and Accounting are in separate exchanges, yet on the same TCP connection. The entire connection is encrypted.
- B. Authentication, Authorization and Accounting are in separate exchanges and each occurs on a different TCP connection. Only the authentication connection is encrypted.
- C. Authentication, Authorization and Accounting are in separate exchanges. Authentication and Authorization happen on the same TCP encrypted connection ; Accounting data is carried unencrypted over UDP.
- D. Authentication, Authorization and Accounting are in separate exchanges, yet on the same TCP connection. Only passwords are encrypted.
- E. Authentication and Authorization is combined in one exchange. Accounting happens in a separate exchange. Authentication and Authorization data are carried on a UDP transport. Only passwords are encrypted. Accounting data is carried unencrypted over another UDP transport.

Answer: A

Question No : 153

Click the Exhibit button: In the shown diagram the browser fails to return a web page when browsing to www.foo.com. The IP addressing is represented by letters next to each device. The domain name www.foo.com resolves to IP address E. A sniffer trace is taken at the PC. What sequence of packets would be observed for this problem:

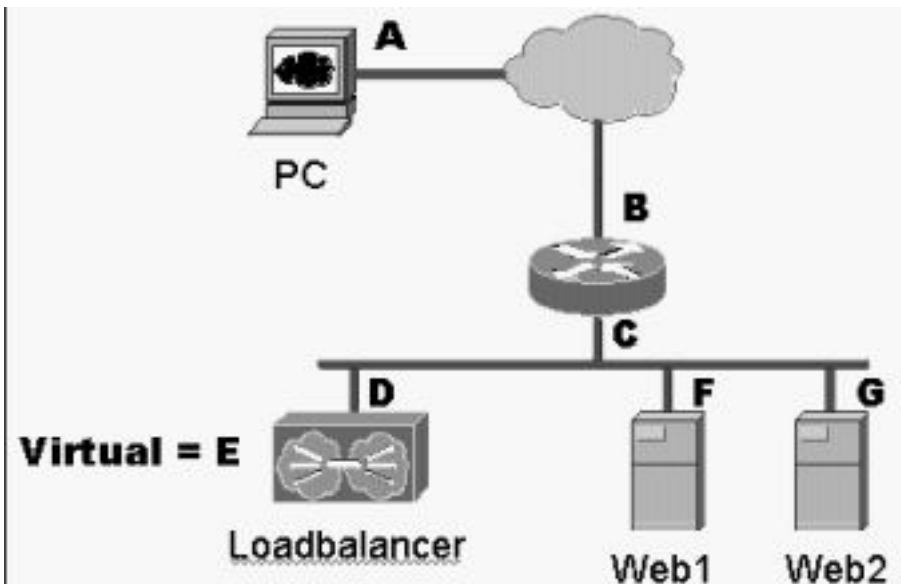

- A. A -> E SYN
- F -> A SYN-ACK
- A -> F RST
- B. A -> D SYN
- D -> A RST
- C. C -> E SYN
- E -> C SYN-ACK
- C -> E ACK
- D. D -> G SYN
- G -> D SYN-ACK
- D -> G ACK
- E. A -> E FIN
- E -> A ACK
- E -> A FIN

Answer: A

Question No : 154

What is the proper format for the inverse DNS mapping for the following address:
198.133.219.25?

- A. 198.133.219.25.in-addr.arpa.
- B. 198.133.219.0.in-addr.arpa.
- C. 0.219.133.198.in-addr.arpa.
- D. 25.219.133.198.in-addr.arpa.
- E. 198.133.25.219.in-addr.arpa.

Answer: D

Question No : 155

Click the Exhibit to view the topology. In this network, Host A is trying to reach Host D. There is no routing protocol running, but Router B and C have the following static routes configured: Router B: ip route 10.1.3.0 255.255.255.0 ethernet 1 Router C: ip route 10.1.1.0 255.255.255.0 ethernet 1

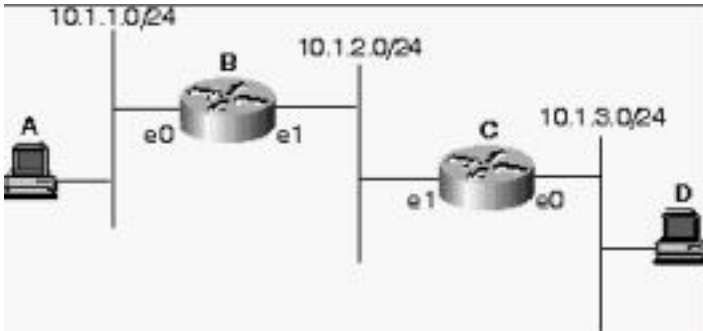

- A. This will not work because Router B has no idea of how to forward traffic to the 10.1.3.0/24 network.
- B. This will work because Router B will recognize that Router C is on the 10.1.2.0/24 network through a router discovery protocol and will forward traffic for 10.1.3.0/24 to Router C.
- C. This will not work because a broadcast interface in a static route command cannot be specified.
- D. This will work because Router B will ARP for Host D's IP address on the 10.1.2.0/24 network and Router C will answer.

Answer: D

Question No : 156

A root CA certificate distinguishes itself from other certificates because:

- A. The root CA certificate has a special bit set in the Key Usage field.
- B. The root CA certificate has its serial number in a dedicated range.
- C. The root CA certificate issuer and subject are the same.
- D. The root CA certificate has a Subject Type equal to CA in its Basic Constraints.
- E. The root CA certificate has a Thumbprint.

Answer: C

Question No : 157

Click the Exhibit to view the topology. Router A has a 512K-access port into the frame relay cloud. Router B has 128K-access port into the frame relay cloud. The two routers are connected with symmetrical PVCs that are configured for 64K committed information rate (CIR). What Frame Relay Traffic Shaping map-class sub-command should be entered on Router A to prevent workstation A from overrunning the access port on Router B?

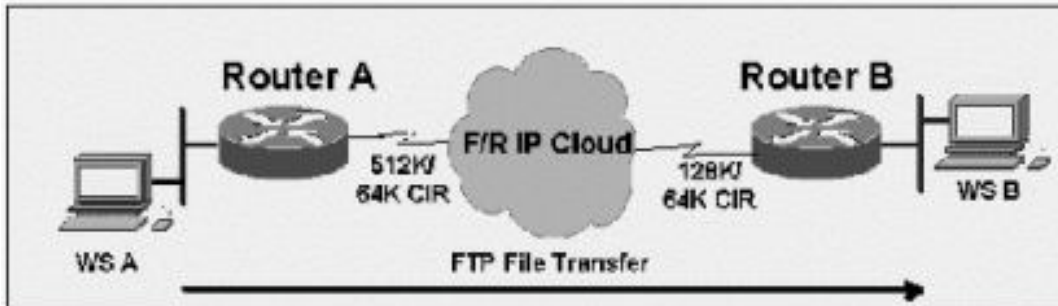

- A. frame-relay traffic-rate 128000 512000
- B. frame-relay traffic-rate 64000 512000
- C. frame-relay traffic-rate 512000 64000
- D. frame-relay traffic-rate 128000 64000
- E. frame-relay traffic-rate 64000 128000

Answer: E

Question No : 158

A router is receiving updates for a subnet from different routing protocols. The administrator wishes to take advantage of a path via a route with a less favorable Administrative Distance. What can be done to affect this without losing any of the updates?

- A. Configure a static route with an Administrative Distance of 120
- B. Use the Router Configuration mode command distance with an appropriate 'weight' for this subnet
- C. Create a distribute-list to block this subnet
- D. Modify the default-metric weight of the routing protocol offering the more favorable Administrative Distance

Answer: B

Question No : 159

Click the Exhibit button. When loadbalancing TACACS+, the loadbalancer needs to:

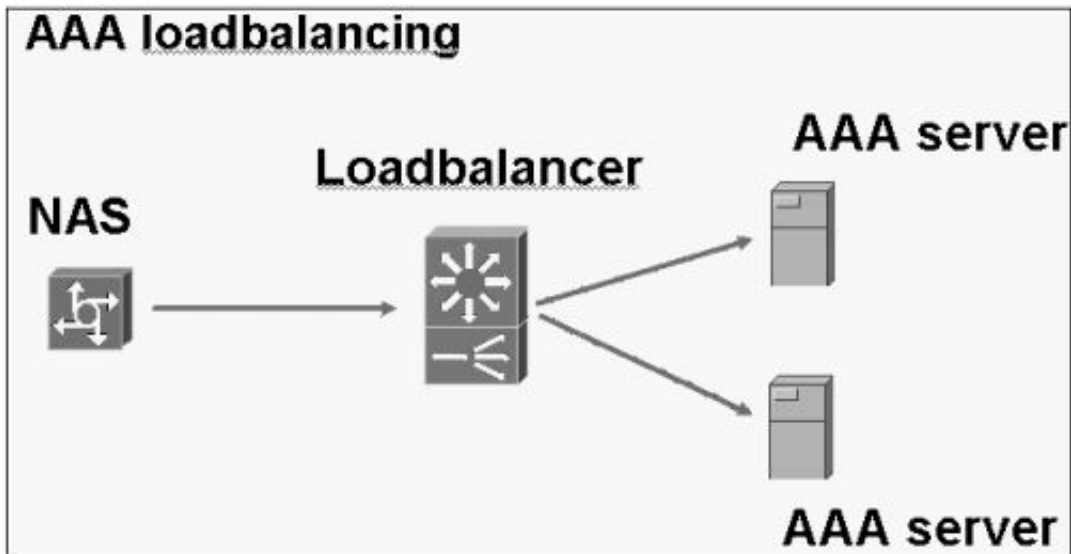

- A. Loadbalance UDP traffic on port 1645, and TCP on port 49
- B. Loadbalance TCP traffic on ports 1645 and 1812.
- C. Be TACACS+-aware and loadbalance on TCP port 49.
- D. Loadbalance TCP traffic on port 49.
- E. Be TACACS+-aware and loadbalance on UDP traffic on port 49.

Answer: D

Question No : 160

What are the communication ports used by the GSS for inter-GSS communication?

- A. UDP 2001-2009 and UDP 3001-3009
- B. UDP 2001-2009 and TCP 2001-2009
- C. UDP 3001-3009 and TCP 3001-3009
- D. UDP 3001-3009 and TCP 2001-2009
- E. TCP 2001-2009 and TCP 3001-3009

Answer: E

Question No : 161

A server load balancer has been configured for sticky source IP load balancing. The web server administrator advises that one of the four equal specification web servers always has more sessions. This is confirmed by the load balancer show commands. What option would not cause the behavior?

-
- A. Users are connecting via a mega-proxy.
 - B. The load balancer is incorrectly configured.
 - C. Users connect with HTTP 1.0.
 - D. Users are port address translated by a firewall.
 - E. All of the above

Answer: C

Question No : 162

GET / HTTP/1.1\r\n Connection: Keep-Alive\r\n User-Agent: Mozilla/4.8 [en]C-CCK-MCD (Windows NT 5.0; U)\r\n Host: www.cisco.com\r\n Accept: image/gif, image/x-xbitmap, image/jpeg, image/pjpeg, image/png, */*\r\n Accept-Encoding: gzip\r\n Accept-Language: en\r\n Accept-Charset: iso-8859-1,*,utf-8\r\n In the above listed HTTP request, which lines are required (by RFC) for an HTTP 1.1 request?

- A. "GET / HTTP/1.1\r\n" and "User-Agent: Mozilla/4.8 [en]C-CCK-MCD (Windows NT 5.0; U)\r\n"
- B. "GET / HTTP/1.1\r\n", "Host: www.cisco.com\r\n" and "Accept-Language: en\r\n"
- C. "GET / HTTP/1.1\r\n"
- D. "GET / HTTP/1.1\r\n" and "Host: www.cisco.com\r\n"
- E. All lines are required

Answer: D

Question No : 163

Parties learn about a CA's Certificate Revocation List (CRL) through:

- A. The CRL which is contained in the CA certificate; It contains a list of all revoked certificates.
- B. The CRL which is contained in the CA certificate; It contains a list of the serial numbers and revocation dates of all revoked certificates.
- C. A CRL Distribution Point or CDP which is contained in the CA certificate and points to a location from which the CRL (a list of the serial numbers and revocation dates of revoked certificates) may be retrieved.
- D. Either the CRL which is contained in the CA certificate, or a CDP from which the CRL may be retrieved. The CRL contains a list of the serial numbers and revocation dates of all revoked certificates.
- E. Either the CRL which is contained in the CA certificate, or a CDP from which the CRL

may be retrieved. The CRL contains a list of all revoked certificates.

Answer: D

Question No : 164

Click the Exhibit button to view the topology. Routers E and F are configured for HSRP (Hot Standby Routing Protocol). E has a priority of 100, while F has a priority of 50. At one point, when E is the active router, it fails, and F takes over as the active router. A few minutes later, E returns to service. What happens?

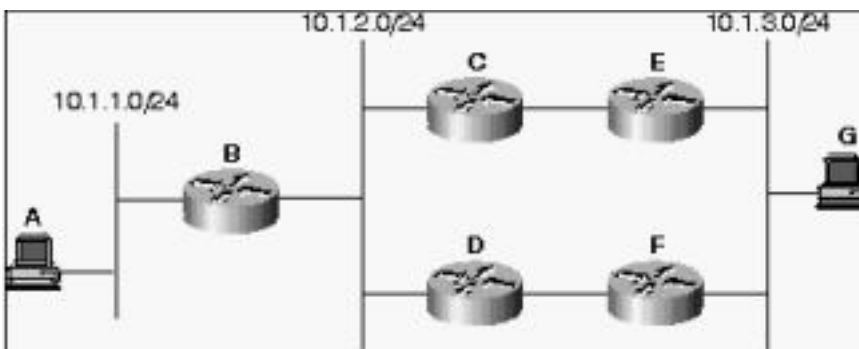

- A. F will remain the active router; there is no way for E to become the active router again unless F fails.
- B. E and F will negotiate which router should be active based on their IP addresses.
- C. E will always take over the active role; there is no way for F to remain active once another router with a higher priority is on the network.
- D. E will become the active router, if it is configured to preempt.
- E. F will remain the active router because having a lower priority is better.

Answer: D

Question No : 165

LDAP can be preferred over X.500 because:

- A. LDAP is a protocol to access Directories and X.500 is not
- B. LDAP is more generic and allows access to all kind of Directories; X.500 is limited to certificate chains
- C. LDAP is a lighter version of X.500 as it uses UDP instead of TCP
- D. LDAP is a lighter version of X.500 as it doesn't require a full OSI stack implementation
- E. LDAP is cross-platform while X.500 runs only on legacy systems

Answer: D

Question No : 166

Click the Exhibit button to view the topology. If Switch C1 is the root of the spanning tree for all VLANs in the network, what ports will be blocking on Switch C1?

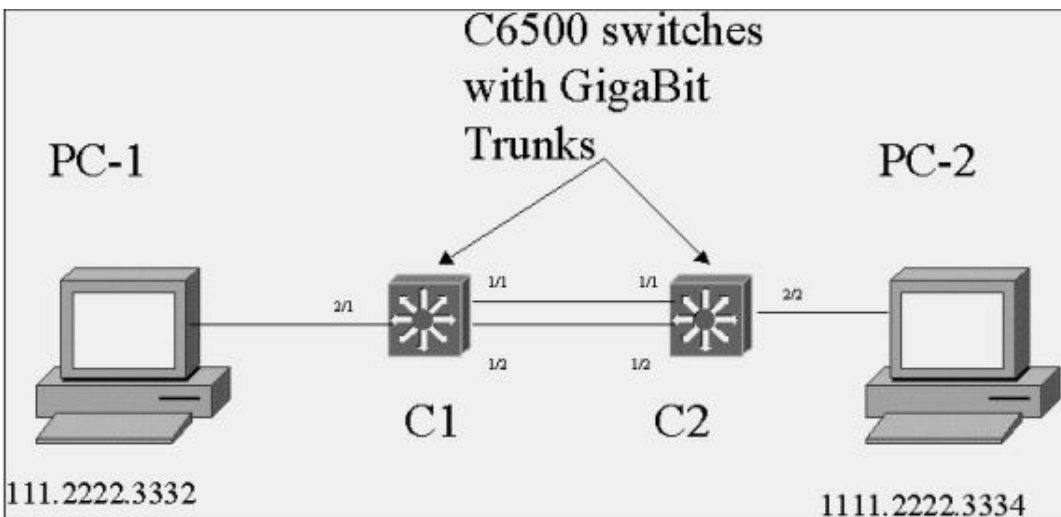

- A. 1/1 only
- B. 1/2 only
- C. Both 1/1, and 1/2
- D. Not enough information

Answer: D

Question No : 167

Click the Exhibit button to view the topology. L3 switches R1 and R2 are in the backbone of the network. They are connected by a routed EtherChannel bundle consisting of eight Gigabit Ethernet ports. The routed link is represented as subnet X.0 in the diagram. Since X.0 is routed, it is not a VLAN trunk. How can spanning tree loops be prevented in the backbone of this network?

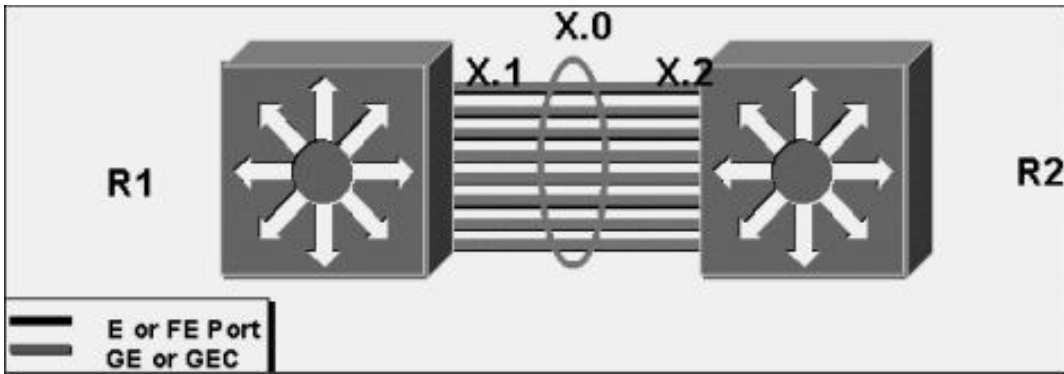

- A. Since EtherChannel X is routed there are no spanning tree loops.
- B. Configure seven of the eight ports in the bundle as passive interfaces
- C. Configure UplinkFast on R1 and R2
- D. Disable Spanning Tree Protocol (STP) on R1 and R2
- E. Disable VLAN X on seven of the eight ports in the bundle

Answer: A

Question No : 168

What statement true about HTTPS?

- A. Web traffic is carried over a separate protocol, unrelated to the original HTTP protocols. This new protocol is HTTPS.
- B. Secure protocols such as tunnel encryption methods are carried over plaintext HTTP.
- C. It is a mechanism for encrypting the HTTP protocol bodies while the keeping the HTTP protocol headers in cleartext.
- D. It uses plaintext HTTP over an encrypting protocol, such as TLS.

Answer: D

Question No : 169

Click the Exhibit button to view the configuration. Which addresses below are appropriate supernets to contain the addresses shown in the exhibit? (multiple answer)

```

192.168.10.0/25
192.168.16.64/26
192.168.0.0/27

```

- A. 192.168.0.0/16
- B. 192.168.0.0/19
- C. 192.168.32.0/19

D. 192.168.1.0/24

Answer: A,B

Question No : 170

ATM switches use the VPI/VCI fields of the cell header:

- A. To identify the QOS parameters specified in the traffic contract between the ATM end station and the network
- B. To determine if the cell should be discarded in preference to others that have not exceeded their traffic envelope
- C. To identify the next intermediate destination to which the cell should be passed
- D. To determine if the header contains a checksum error and should be discarded
- E. To determine if the cell contains user data or control data

Answer: C

Question No : 171

Click the Exhibit button. A client at the PC is unable to browse to <http://www.foo.com>. On the firewall, what list of traffic types needs to be passed to allow browsing?

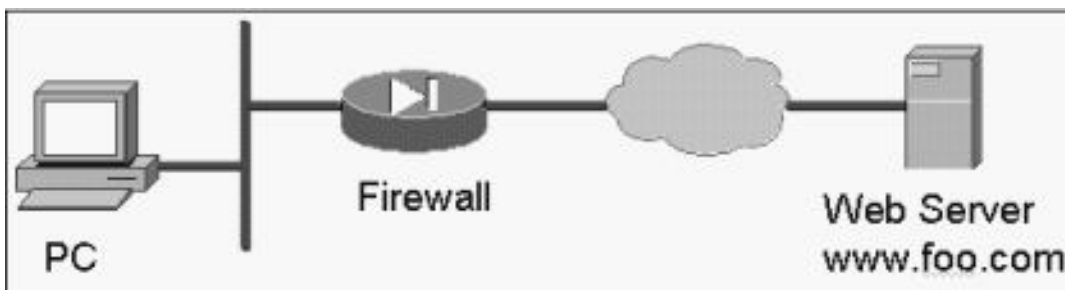

- A. icmp, udp 1645, tcp 8080
- B. udp 53, tcp 80, ftp
- C. ftp, smtp, dns
- D. icmp, tcp 49, tcp 443
- E. tcp 25, ssl, dns

Answer: B

Question No : 172

What is Forwarding Equivalence Class assignment NOT likely to be based upon?

- A. Fragment offset
- B. Destination address
- C. Application protocol
- D. Class of service

Answer: A

Question No : 173

When using IS-IS for IP routing, Dual IS-IS defined by RFC 1195, what is true? (multiple answer)

- A. It is necessary to configure a NSAP address.
- B. It is not possible to perform both IP and CLNS routing with the same process.
- C. IP address and subnet information is carried in the TLV field on the L-1/L-1 LSPs.
- D. Dual IS-IS does not support VLSM information.

Answer: A,C

Question No : 174

What is true about the DLCI field in the Frame Relay header?

- A. It consists of two portions, source and destination, which map data to a logical channel.
- B. It generally has significance only between the local switch and the DTE device.
- C. It is an optional field in the ITU-T specification.
- D. It is present only in data frames sent through the network.

Answer: B

Question No : 175

An LDAP Directory Information Tree is built of:

- A. Nodes called entries, which contain attributes, which in turn are type/value pairs
- B. Nodes called entries, which contain arbitrary ASN.1 PDUs
- C. Nodes called attributes, which are lists of entries, which in turn are type/value pairs
- D. Nodes called entries and edges which can have attributes

E. Tables contain rows and columns; The first column in a row is the entry name, the subsequent columns are attributes

Answer: A

Question No : 176

What is the standard HTTP 1.1 response code for a proxy that requires authentication of a user?

- A. 200
- B. 407
- C. 302
- D. 100
- E. 401

Answer: B

Question No : 177

Select the group of technologies which are listed in descending order of bandwidth scale:

- A. SDH, X.25, ATM
- B. DWDM, SDH, Frame Relay
- C. DWDM, SDH, ATM
- D. ATM, DWDM, Frame Relay

Answer: C

Question No : 178

During an SSL transaction, when a client tries to authenticate the server, the client will:

- A. Check that the server certificate has not expired
- B. Use the Issuer public key to verify the signature of the server certificate
- C. Use the Subject public key to verify the signature of the server certificate
- D. A and B
- E. A and C

Answer: D

Question No : 179

What IE is not mandatory in a Q.931 Service msg?

- A. Bearer capability
- B. Channel ID
- C. Message Type
- D. Change Status
- E. Call Reference

Answer: A

Question No : 180

Below are four 'out' access-lists, configured on an interface. What list will block an IP packet with source address 144.23.67.94, destination address 197.55.34.254, destination TCP port 23 from leaving the router?

- A. access-list 100 deny ip tcp 144.23.67.0 0.0.0.7 eq telnet 197.55.34.240 0.0.0.15 eq telnet
access-list 100 permit ip any any
- B. access-list 100 deny tcp 144.23.67.94 0.0.0.7 any eq telnet
access-list 100 permit ip any any
- C. access-list 100 deny tcp 144.23.67.86 0.0.0.7 eq telnet 197.55.34.240 0.0.0.15
access-list 100 permit ip any any
- D. access-list 100 deny ip 144.23.67.94 0.0.0.7 host 144.23.67.94
access-list 100 permit ip any any

Answer: B

Question No : 181

This is the CSS11000 configuration. www.foo.com resolves to the IP address 80.80.80.80
content rule1 protocol tcp vip address 80.80.80.80 port 80 url "/"* add service web3 add
service web4 active content rule2 protocol tcp vip address 80.80.80.80 port 80 url
"/question/*" add service web1 add service web2 active A web page is not returned from
application on web servers web1 and web2. The URL the client is requesting

(http://www.foo.com) resides on web1 and web2. What configuration change is required to return the correct page?

- A. content rule1
url "http://www.foo.com/*"
- B. content rule2
url "http://www.foo.com/question/*"
- C. content rule1
url "http://www.foo.com/picture/*"
- D. content rule2
url "/picture/*"
- E. content rule1E.content rule1
No url

Answer: D

Question No : 182

What is a possible way to avoid assymetric traffic flow when using the CSM for server load balancing and the CSM's server side VLAN has an IP address configured on the MSFC?

- A. In the server farm use the client nat command with a nat pool.
- B. Use policy based routing to force traffic through the CSM's client side VLAN.
- C. Use policy based routing to force traffic through the CSM's server side VLAN.
- D. Set the server's default gateway to the CSM's client side IP address.

Answer: A,C

Question No : 183

SSL Session ID is used to:

- A. Resume old SSL sessions -- the keys remain the same
- B. Give loadbalancers the opportunity to loadbalance SSL based upon a non-encrypted field that stays constant throughout one session, yet is guaranteed to change between sessions
- C. Resume old SSL sessions -- the keys are recomputed using the old master_secret and new random values
- D. Allow the client to distinguish between the various SSL connections it has to a server
- E. Allow the server to distinguish between the various SSL connections it has to a client

Answer: C

Question No : 184

Click the Exhibit button. In the shown diagram the USER is accessing the web application farm for content on port 80 through 7500-1. 7500-1 has WCCP enabled on the router. CE590 is pointing to 7500-1 as a WCCP router. What is the best method of redirection in this topology?

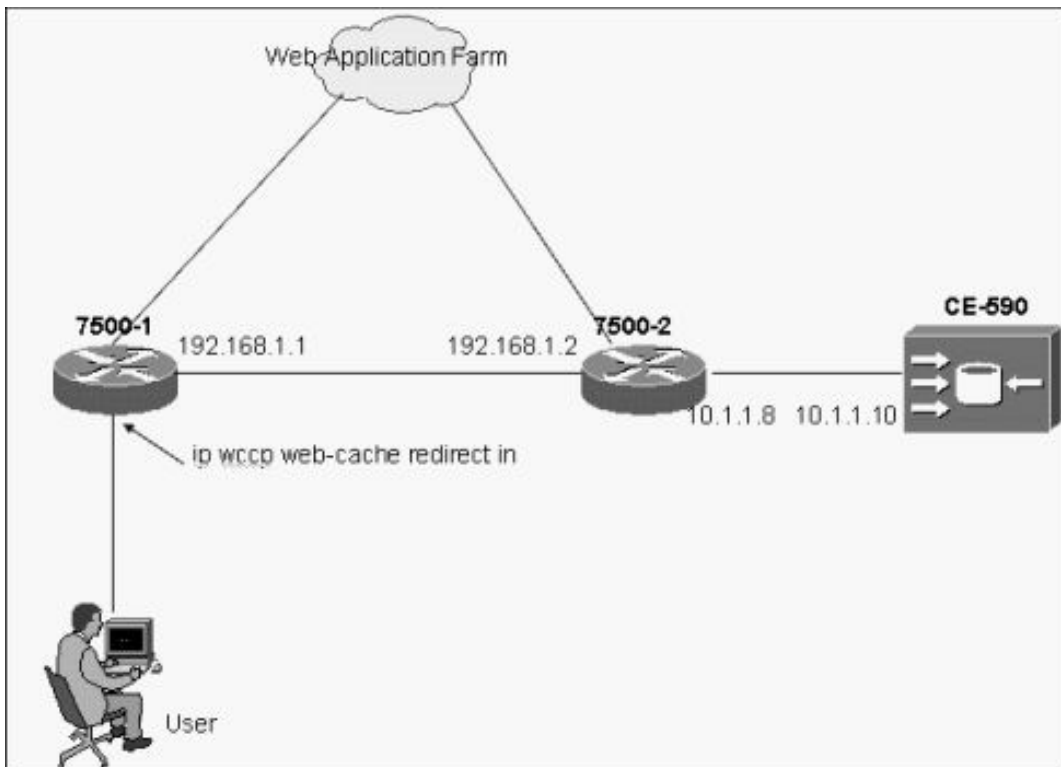

- A. Route map on 7500-1; setting port 80 destined traffic's next hop to 7500-2
- B. Route map on 7500-1; setting port 80 destined traffic's next hop to CE-590
- C. GRE redirection
- D. Layer 2 redirection
- E. Layer 2 redirection with mask assign

Answer: C

Question No : 185

Please refer to the following line from a content engine transaction log. 1012429341.115 100 172.16.100.152 TCP_REFRESH_MISS/304 1100 GET http://www.cisco.com/images/homepage/news.gif - DIRECT/www.cisco.com What does the 304 mean in this log?

-
- A. The complete content was retrieved from the origin server.
 - B. The complete content was served out of the cache.
 - C. An If-modified-since request was sent from the client and the complete content was sent back to the client.
 - D. An If-modified-since request was sent from the client and a not modified response code was sent back to the client.
 - E. 304 bytes of data was sent back to the client.

Answer: D

Question No : 186

When configuring the GSS DNS rule balancing method, what do we also call the boomerang method?

- A. DNS race
- B. DNS Last Gasp
- C. Last Gasp
- D. Last Hop
- E. None of the above

Answer: A

Question No : 187

For communications systems what describes the over-all health of the system?

- A. Bit-Error-Rate (BER)
- B. Synchronous Optical NETWORK (SONET)
- C. Optical Signal to Noise Ratio (OSNR)
- D. None of the above

Answer: A

Question No : 188

The purpose of Administrative Distance, as used by Cisco routers, is:

- A. To choose between routes from different routing protocols when receiving updates for

the same network

- B. To identify which routing protocol forwarded the update
- C. To define the distance to the destination used in deciding the best path
- D. To be used only for administrative purposes

Answer: A

Question No : 189

Within Cisco's Application and Content Networking Software Version 5 and above, Simplified Hybrid Routing utilizes 2 standard protocols to direct a client to a local CE. What are they ?

- A. WCCP and proxy
- B. Layer 2 redirects and HTTP
- C. DNS and WCCP
- D. HTTP and HTTPS
- E. DNS and HTTP

Answer: E

Question No : 190

Click the Exhibit button to view the topology. Routers E and F are running HSRP (Hot Standby Router Protocol). Router E has a higher priority, and both routers have standby preempt configured. Since Router E is normally the active router, what IP address should Host G use for its default gateway?

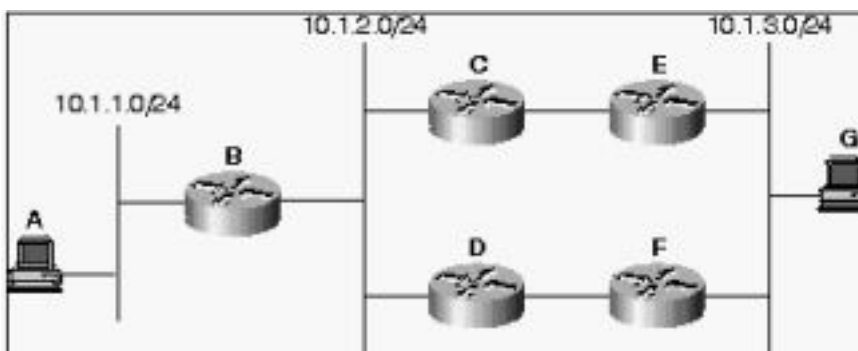

- A. 10.1.3.1
- B. Router E's IP address, since it is normally active; Router F will take over Router E's address if it fails.
- C. Router F's IP address; the active router will take over the standby router's IP address until it fails

-
- D. The virtual address configured when enabling HSRP
 - E. The virtual address assigned by HSRP; this address is dependent on the group number configured

Answer: D

Question No : 191

Commercial browsers such as Netscape or Internet Explorer have knowledge of existing root CA certificates because:

- A. They connect to netscape.com or microsoft.com to download the current list of CA certificates each time the user is on-line.
- B. A number of root CA certificates is already installed in the software. Users can then manually add or remove certificates to this list.
- C. A number of root certificates is already installed in the software. This list cannot be altered, but companies can request intermediary CA certificates to be signed by one of these root CAs.
- D. There exists a standard that outlines which CA's can be trusted ; the browser checks the CA certificate against this standard.
- E. During installation of the browser, the install program will download the latest list of trusted root CA certificates from download.rsa.org and install these with the browser.

Answer: B

Question No : 192

If two routers connected to the same Ethernet are configured to run HSRP (Hot Standby Router Protocol) in the same group number, which router's MAC address will be associated with the virtual IP address?

- A. It depends on which router is active.
- B. Neither - a virtual MAC address will be assigned based on the group number, unless the routers are configured to use their burned in addresses (BIA).
- C. The routers will negotiate and decide automatically which MAC address to use based on the routers' IDs.
- D. Both routers' MAC addresses will be associated with the virtual IP address.
- E. Neither - the hosts will broadcast all traffic which needs to travel off-segment.

Answer: B

Question No : 193

Click the Exhibit button. In the shown diagram how does WCCP on the router decide which cache to send a request from the user?

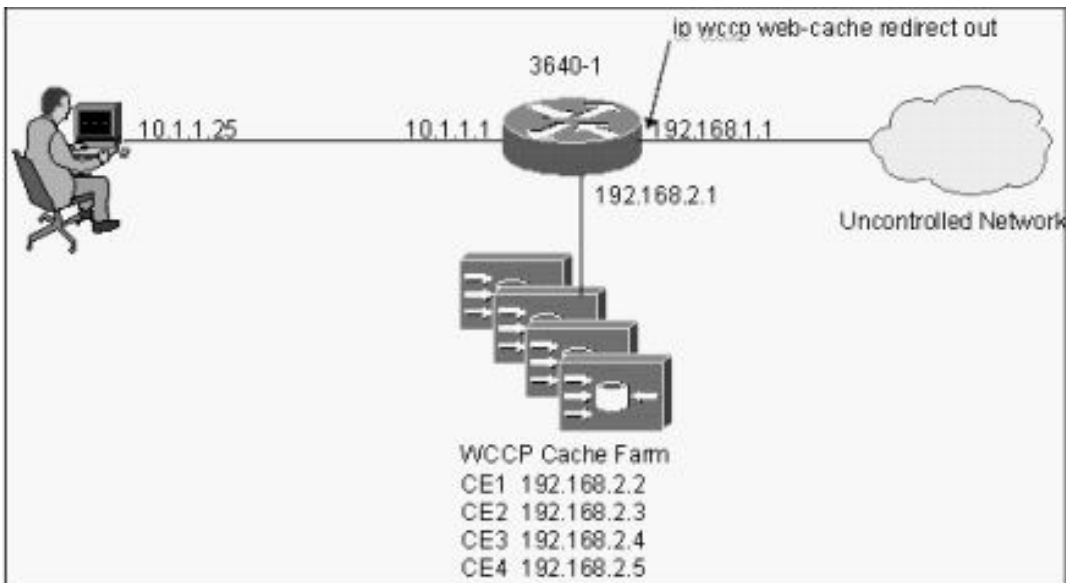

- A. It randomly selects a cache.
- B. It uses the source address of the request and hashes to a cache.
- C. It uses the destination address of the request and hashes to a cache.
- D. It uses the source and destination address of the request and hashes to a cache.
- E. It uses the source port of the request and hashes that to a cache.

Answer: C

Question No : 194

The configuration register does NOT retain settings for:

- A. An enabled 'Break' key
- B. The console baud rate
- C. The boot method
- D. An enabled AUX port

Answer: D

To Read the [Whole Q&As](#), please purchase the [Complete Version](#) from [Our website](#).

Trying our product !

- ★ **100%** Guaranteed Success
- ★ **100%** Money Back Guarantee
- ★ **365 Days** Free Update
- ★ **Instant Download** After Purchase
- ★ **24x7** Customer Support
- ★ Average **99.9%** Success Rate
- ★ More than **69,000** Satisfied Customers Worldwide
- ★ Multi-Platform capabilities - **Windows, Mac, Android, iPhone, iPod, iPad, Kindle**

Need Help

Please provide as much detail as possible so we can best assist you.

To update a previously submitted ticket:



 One Year Free Update <p>Free update is available within One Year after your purchase. After One Year, you will get 50% discounts for updating. And we are proud to boast a 24/7 efficient Customer Support system via Email.</p>	 Money Back Guarantee <p>To ensure that you are spending on quality products, we provide 100% money back guarantee for 30 days from the date of purchase.</p>	 Security & Privacy <p>We respect customer privacy. We use McAfee's security service to provide you with utmost security for your personal information & peace of mind.</p>
---	---	--

[Guarantee & Policy](#) | [Privacy & Policy](#) | [Terms & Conditions](#)

Any charges made through this site will appear as Global Simulators Limited.

All trademarks are the property of their respective owners.

Copyright © 2004-2015, All Rights Reserved.